



*Engineering  
Services*

[www.westengineer.com](http://www.westengineer.com)

# ***SHEAR RAM CAPABILITIES STUDY***

For

U.S. Minerals Management Service

Requisition No. 3-4025-1001

**September 2004**

# TABLE OF CONTENTS

<b>1. Executive Summary.....</b>	<b>1</b>
<b>2. Background .....</b>	<b>1</b>
<b>2.1 Study Parameters .....</b>	<b>1</b>
<b>2.2 Industry Information.....</b>	<b>1</b>
<b>2.3 Material Properties .....</b>	<b>3</b>
<b>2.4 Miscellaneous .....</b>	<b>3</b>
<b>3. Discussion.....</b>	<b>1</b>
<b>3.1 Data Acquisition.....</b>	<b>1</b>
<b>3.2 Understanding the Shear Function.....</b>	<b>1</b>
<b>3.3 Drill Pipe Evolution.....</b>	<b>1</b>
<b>3.4 Tool Joints and Upset Areas.....</b>	<b>2</b>
<b>3.5 Previous Field Failure .....</b>	<b>4</b>
<b>3.6 Predictive Testing .....</b>	<b>5</b>
<b>3.7 Shear Ram and Ram Lock Configurations .....</b>	<b>5</b>
<b>3.8 Stack Configuration.....</b>	<b>6</b>
<b>3.9 Shearing with Surface Stacks.....</b>	<b>6</b>
<b>3.10 Pipe Handling and Mux Control System.....</b>	<b>6</b>
<b>3.11 MMS Requirement .....</b>	<b>7</b>
<b>3.12 Risk and Safety .....</b>	<b>7</b>
<b>4 Shear Data from the Manufacturers .....</b>	<b>1</b>
<b>4.1 Material Properties .....</b>	<b>1</b>
<b>4.2 BOP and Shear Ram Parameters .....</b>	<b>2</b>
<b>4.3 Rationalization of Data .....</b>	<b>3</b>
<b>4.4 Differences Between Manufacturers .....</b>	<b>3</b>
<b>4.5 Charpy Impact vs. Elongation.....</b>	<b>3</b>
<b>4.6 BOP Available Shear Force.....</b>	<b>4</b>
<b>4.7 Data Spreadsheet and Graphs .....</b>	<b>5</b>
<b>4.8 Data Correlation.....</b>	<b>6</b>
<b>5 Statistical Analysis.....</b>	<b>1</b>
<b>5.1 Rationale of Statistical Analysis.....</b>	<b>1</b>
<b>5.2 Histograms for better understanding of the data.....</b>	<b>2</b>
<b>5.3 Regression Analysis.....</b>	<b>9</b>

<b>6 Additional Shearing Pressure Required.....</b>	<b>1</b>
<b>7 Test Procedures Used.....</b>	<b>1</b>
<b>7.1 Shear Ram Test.....</b>	<b>1</b>
<b>7.2 Drilling Rig.....</b>	<b>3</b>
<b>8 Summary of Recommendations .....</b>	<b>1</b>
<b>9 Industry References.....</b>	<b>1</b>
<b>9.1 API Specification 16A, 2<sup>nd</sup> Edition .....</b>	<b>1</b>
<b>9.2 API RP 53 3<sup>rd</sup> Edition .....</b>	<b>2</b>
<b>9.3 MMS.....</b>	<b>2</b>
<b>9.4 NPD.....</b>	<b>3</b>
<b>9.5 UK.....</b>	<b>3</b>
<b>9.6 NORSOK.....</b>	<b>4</b>
<b>9.7 Interpretation, all referenced regulatory requirements and standards: .....</b>	<b>4</b>
<b>9.8 Discussion:.....</b>	<b>4</b>
<b>9.9 Internal WEST References.....</b>	<b>4</b>
<b>10 Glossary of Terms.....</b>	<b>1</b>
<b>11 Works Cited.....</b>	<b>1</b>
<b>12 Appendix.....</b>	<b>1</b>

# 1. Executive Summary

WEST was commissioned by the United States Minerals Management Service (MMS) to perform the Shear Ram Capabilities Study. The main goal of the study was to answer the question “Can a rig’s blowout preventer (BOP) equipment shear the pipe to be used in a given drilling program at the most demanding condition to be expected, and at what pressure?” Shear rams may be a drilling operation’s last line of defense for safety and environmental protection.

Code of Federal Regulations, Title 30 Mineral Resources, Chapter II – Minerals Management Service, Department of the Interior, Subchapter B – Offshore, Part 250 – Oil and gas and sulphur operations in the Outer Continental Shelf asks in 250.416(e): “What must I include in the diverter and BOP descriptions?” And the answer is stated as: “Information that shows the blind-shear rams installed in the BOP stack (both surface and subsea stacks) are capable of shearing the drill pipe in the hole under maximum anticipated surface pressures.” Therefore, an operator is responsible to assure the BOP shear rams will reliably shear the drill pipe in the particular operational conditions.



Drill pipe properties have been improved to support drilling operations, last longer and to reduce probability of drill pipe failure. The improvements in drill pipe properties, particularly increased material strength and ductility, have also resulted in higher forces required to shear the drill pipe. Drill pipe diameter and wall thickness is periodically optimized, requiring increased diligence concerning shearing ability. Increased water depths in combination with drilling fluid density and shut-in pressure contribute to a BOP having to generate additional force to affect a shear.

Data from three BOP shear ram manufacturers and one drill pipe manufacturer were collected for analysis in the study. Drill pipe mechanical properties considered significant in the study were yield strength, ultimate strength, and ductility. Indicators of the ductility are Charpy Impact and Elongation % values where higher values generally indicate increased ductility.

The Distortion Energy Theory shear force equation is discussed throughout the report and is as follows:

$$F = 0.577 \times S_Y \times \text{Area}$$

Where:

$S_Y$  = drill pipe material yield strength (psi)

Area = cross-sectional area of the drill pipe. (sq inch)

The Distortion Energy Theory shear equation method, while being reasonable, was found not to consistently predict the highest actual shear forces.

The data obtained from the manufacturers was statistically evaluated in order to understand the risk of not being able to shear the pipe and predict shear forces. The data for E-75, G-105 and S-135 drill pipe was reviewed to recognize the distribution of shear points for the same type of pipe – with a concentration on S-135. Each was examined statistically (with histograms) so the reader can visualize the data's shearing distribution. Regression analysis was used with yield strength (Distortion Energy Theory) and Elongation % being independent variables in predicting shear force. Equations that best fit the data provided using the regression analysis (including safety factor) are as follows:

Generally:

- Calc Fit Shear Force (Kips) = C + A x Distortion Energy Shear Calc. (Kips) + B x Elongation % + 2 x StErr of Estimate  
Or = C + A x (0.577 x Material Yield x Cross sec. Area of drill pipe) + B x Elongation % + 2 x StErr of Estimate

For S-135 Pipe:

- Calc Fit Shear Force (Kips) = -35.11+ 0.630 x Distortion Energy Shear Calc. (Kips) + 4.489 x Elongation% + 2 x 76.69

For G-105 Pipe:

- Calc Fit Shear Force (Kips) = 181.33+ 0.396 x Distortion Energy Shear Calc. (Kips) + 2.035 x Elongation % + 2 x 62.89

For E-75 Pipe:

- Calc Fit Shear Force (Kips) = -234.03+-0.318 x Distortion Energy Shear Calc. (Kips) + 25.357 x Elongation % + 2 x 62.03

In general, the formula used is as follows:

$$Y = C + A \times X1 + B \times X2 + 2 \times \text{StErr of Estimate}$$

Where critical variables are as follows:

Y = Calculated fit shear force in Kips

C = Constant

X1 = Predicted shear using Energy Distortion Theory shear equation in Kips

A = Multiplier on X1 developed from Regression Analysis

X2 = Elongation %

B = Multiplier on X2 developed from Regression Analysis

StErr of Estimate = Standard Error (See Glossary of Terms)

Two of the three BOP manufacturers use the Distortion Energy Theory shear equation to predict the forces necessary for pipe shearing. The third did not provide their equation and all that is known is that they use the material's elongation to adjust their shear force calculation. Regardless, WEST noted that variations of the Distortion Energy Theory and different mechanical properties data were used in the calculations. Differences in drill pipe mechanical properties recorded by the manufacturers complicated analysis and comparison of shearing data.

WEST main conclusions and recommendations include the following:

- BOP stacks should be designed to shear drill pipe using conservative information to best assure reliable shearing, i.e., maximum anticipated drill pipe OD and wall thickness, drill pipe material strength, ductility, and wellbore pressure. Thus critical drill pipe specifications should be provided to the BOP manufacturers. The shear ram capability should be reviewed for conditions that may be encountered in each particular drilling program. Similarly, existing stacks in use should be confirmed as being able to shear drill pipe in use. As drill pipe improves in strength and has dimensional changes, the users must initiate new tests or verification of the ability to shear.
- The above equations were statistically developed in the study to calculate shear force requirements based upon drill pipe mechanical and dimensional properties. Two steps are important—predict the shear point and add a safety factor—manufacturers are currently adjusting the Distortion Energy Theory in order to do both with one calculation. The study developed equations that provide a better model of the available shear data than those used by the BOP manufacturers.
- The above equations will become more accurate with more data points. MMS should encourage data sharing and more standard testing. To that end it would be useful to establish an industry wide database of shear forces/pressures. Standardization of drill pipe mechanical properties recording and sharing of data by BOP manufacturers would facilitate analysis of shear data and development of more accurate models.
- Develop a computer spreadsheet incorporating the shear force equations for use in the oil and gas drilling industry. Resultant calculated shear forces could be used to evaluate BOP stack specifications for particular drilling operations, where most variables are known. In the event BOP stack capability to deliver adequate shear force is insufficient or questionable, the operator would have the opportunity to implement shear tests to determine actual shearing reliability.

## 2. Background

### 2.1 Study Parameters

The critical safety and environmental nature of the shear ram function prompted this study for the Minerals Management Service (MMS) to more clearly understand and define operating limits of equipment performing this task. Shear rams are often the last line of defense and must be available and capable when needed. Advances in drill pipe metallurgy, combined with larger and heavier pipe sizes used in modern drilling programs have resulted in instances where pipe on a rig may not be successfully sheared and the wellbore sealed. The goal was to answer the question: “Can a rig’s BOP equipment shear the pipe to be used in a given drilling program at the most demanding condition to be expected, and at what pressure?” The most demanding condition includes: maximum material condition, strength and ductility for the pipe and the maximum wellbore pressure in the bore (mud head and kick pressure equaling the working pressure).

The research objectives/*findings* of the program were originally stated as follows:

- 1) Review and compare the different manufacturers' shear testing and reporting criteria. If significant differences exist, recommend standards. *Differences between manufacturer reporting were numerous. They all gave shearing pressure, which WEST converted to shear force. Some gave Charpy Impact values but at varying temperatures, some gave Elongation %'s, some gave pipe hardness, most gave yield strengths, and most gave ultimate tensile strengths.*
- 2) Review and compare the different manufacturers' shear testing results for various sizes and grades of pipe. Evaluate deficiencies in coverage including how manufacturers account for wellbore pressure due to kicks and varying mud weights in the wellbore. Develop parameters for operators to use when planning their programs. *Different shear testing results have been evaluated statistically for evaluation herein.*
- 3) Review known equipment failures and failures to shear and seal. Elaborate on predictive and preventive measures.
- 4) Review configuration options for placing shear rams in the stack. Report advantages on specific configurations when considering specific drilling conditions such as water depth and modes of disconnect required.

In addition to data obtained from shear ram manufacturers, information was obtained from a major drill pipe manufacturer, Grant Prideco, to help understand the improvements and variances in drill pipe and the effects on the shearing capability of shear rams.

### 2.2 Industry Information

The industry has utilized the Distortion Energy Theory shear equation in estimating whether a given shear ram will shear pipe. Differences in approach exist. The Distortion Energy Theory shear equation using the material yield (as is normal) is recommended by Cameron. When compared to our data it provided shear forces lower than required or desired in many cases; in other words, there was little safety factor built in. If the ultimate strength of the material is substituted for the yield strength, as is recommended by Varco Shaffer, the calculated shear force provides a better approximation, but still is not sufficiently high to cover all cases. Hydril too uses the Distortion Energy Theory in some form but their approach was not provided. It seems that the Distortion Energy Theory shear equation with some adjustment should be a good predictor or shear force. This approach is taken herein.

What is most interesting about using the Distortion Energy Theory Shear equation is that in earlier attempts by one of the authors to find a suitable shear equation in the 1980's it was found that this equation was too far off to even consider. This was in the days of brittle S-135 drill pipe and prevalent use of E-75, X-95 and G-105. Modern S-135 pipe properties have improved considerably, which probably accounts for the equation appearing to be more accurate now. Additionally, even though we call them "Shear Rams", the rams do not shear as much as break the drill pipe. It would follow that a "shear equation" might not work for this drill pipe "breaking" operation. The blades actually shear into the pipe a small distance setting up a stress riser, and then the pipe is broken in tension by the rake angle of the blades. See the Figure 2.1.

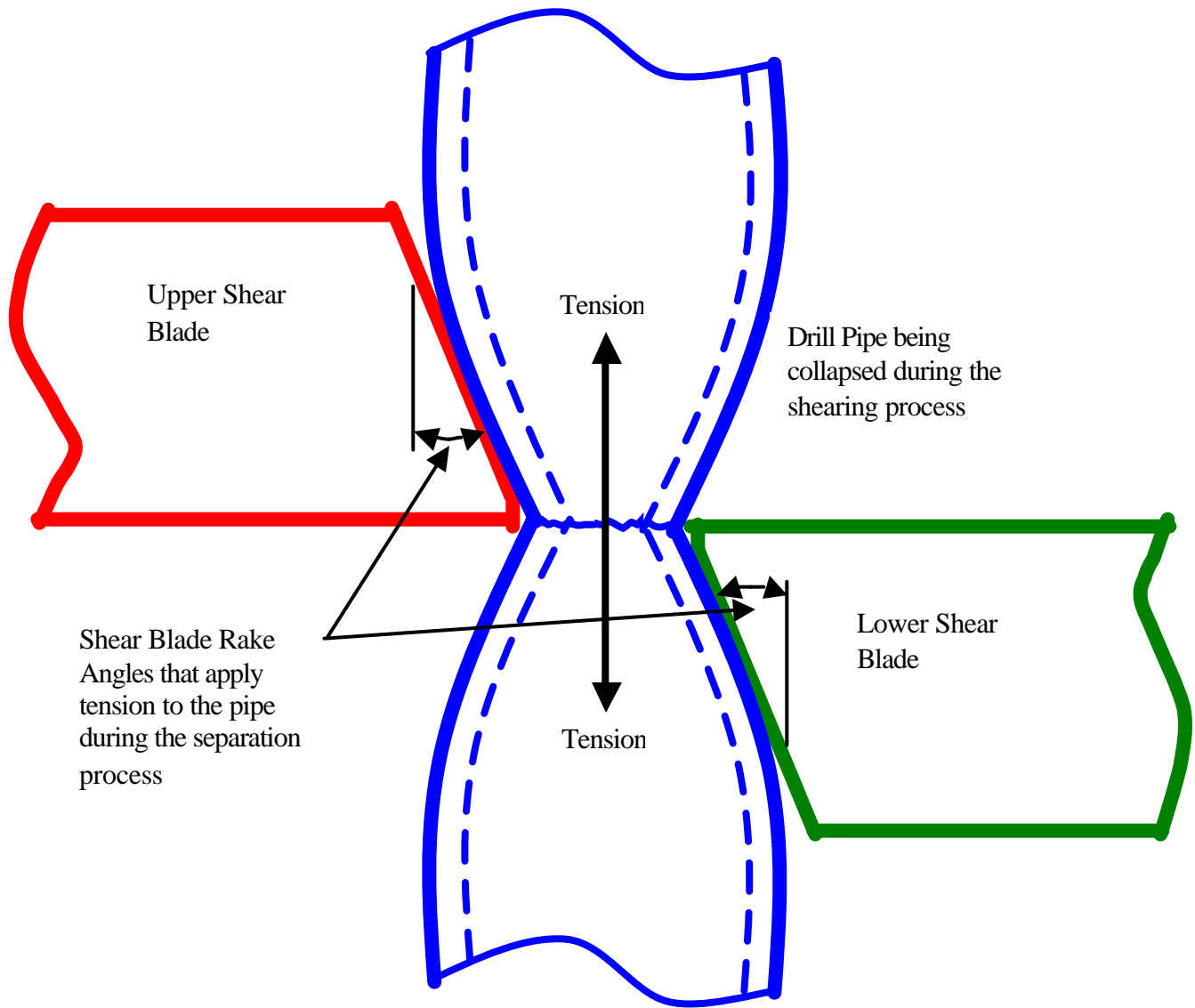

**Figure 2.1**  
**Upper and Lower Shear Blades crushing the drill pipe and beginning the shearing (or breaking) operation**



## **2.3 Material Properties**

The importance of a material's ductility was evident from the above experience as well as the failure of certain high ductile S-135 materials to shear as expected. Therefore, within this paper the relationship of shear force to ductility is evaluated. Two indicators of a material's ductility are Charpy impact and Elongation %, with higher values generally indicating increased ductility. Difficulty arises, as stated elsewhere herein, because the data was not collected consistently. Some collect Charpy impact values while others utilize the Elongation %. More on this topic is provided in Sections 3 and 4.

## **2.4 Miscellaneous**

Consistent testing methodologies along with standard considerations for operational parameters will improve the accuracy of the shear tests and thus the improved probability of success when a shear operation is required. Currently, manufacturers, operators, and contractors use various means to determine if drill pipe will shear, with some inconsistency.

The Glossary of Terms (Section 10) should be reviewed before advancing too far into this report. The mix of engineering, metallurgical and probability terms can be confusing. Every attempt was made to standardize terminology.

## **3. Discussion**

### **3.1 Data Acquisition**

Upon being awarded this study, WEST began efforts to obtain the data required. Accordingly, four manufacturers were contacted. There was a reluctance to share data for a myriad of reasons; therefore, much time and effort was necessarily spent in this area. Eventually, Cameron, Hydril and Grant Prideco provided their data and the MMS provided data that had previously been provided to them by Varco Shaffer. At that point we began sorting through and analyzing the data provided.

### **3.2 Understanding the Shear Function**

The well control function of last resort is to shear pipe and secure the well with the sealing shear ram. As a result, failure to shear when executing this final option would be expected to result in a major safety and/or environmental event. Improved strength in drill pipe, combined with larger and heavier sizes resulting from deeper drilling, adversely affects the ability of a given ram BOP to successfully shear and seal the pipe in use. WEST is currently aware of several failures to shear when conducting shear tests using the drill pipe that was to be used in the well.

As stated in a mini shear study recently done for the MMS, only three recent new-build rigs out of fourteen were found able to shear pipe at their maximum rated water depths. Only half of the operators accepting a new-build rig chose to require a shear ram test during commissioning or acceptance. This grim snapshot illustrates the lack of preparedness in the industry to shear and seal a well with the last line of defense against a blowout.

Operators and drilling contractors do not always perform shear tests when accepting new or rebuilt BOP stacks. The importance of shear tests prior to accepting a rig is better understood by some that have experienced inadequate control system pressure when attempting to shear the drill pipe to be used in their project. Shearing problems found in testing have resulted in delays as the necessary equipment modifications are made before initiation of drilling.

Manufacturers cannot directly compensate for parameters such as mud weight and internal wellbore pressure in the shearing operation; but they do provide the additional compensating pressures required. There has also been little sharing of shear data that would allow for better understanding of shear requirements. Unfortunately, not all operators and drilling contractors are aware of the limitations of the equipment they are using. This study examines existing shear data, and inconsistencies in an attempt to better understand the likelihood that the rams will function as expected when activated.

### **3.3 Drill Pipe Evolution**

As the drill pipe manufacturers have improved drill pipe technology over the years, the latest generation of high ductility pipe, known by various names, has been seen in some cases to almost double the shearing pressure compared to lower ductility pipe of the same weight, diameter, and grade. Higher ductility drill pipe can be evidenced mainly by higher Charpy impact values and slightly lower yield strengths with the Elongation % and hardnesses basically unchanged. See Table 4.1 below. Differences between the high and low ductility drill pipe cannot be visually discerned, although this data may be available on a case-by-case basis. Short of physical testing, only careful record keeping on a rig can determine which pipe is of what specification. Of equal concern, drill pipe tool joints and internal upsets can be quite problematic. Both tool joints and internal upsets are getting bigger and longer.



**Figures 3.1 and 3.2:** Example shears of low ductility or brittle pipe (left) and high ductility pipe (right). The high ductility pipe required almost 2,000 psi (over 300,000 lb) more to shear than the low ductility pipe even though the grades on both pipes were the same, S-135. Visual differences in the shears can also be easily noted: the brittle pipe on the left has cracking on the sides and did not collapse as much as the more ductile pipe on the right. The ductile pipe had no cracking on the sides. In the severest of cases, very brittle pipe cracks considerably when being collapsed by the shear rams and then requires less force to complete the shear.

Considerable historical test data was obtained. Because of differences in recorded critical physical properties, comparisons and suitability for correlations become difficult. Accordingly some data was necessarily not used in some statistical calculations. Currently, many estimates of shear forces do not include Charpy impact or Elongation %, reducing accuracy and mandating a physical shear test to establish shear requirements. Additional research may be needed to confirm methods of estimating shear pressure for the full range of pipe available today. This includes performing controlled shear tests on each new size or grade of drill pipe that becomes common in the field. Incorporating ductility should improve the accuracy of these estimates and possibly lessen the reliance on actual shear tests. This study addresses the shear force and ductility issue by evaluating the data statistically.

This study concentrates on shearing drill pipe only, excluding tool joints. If there are concerns on tubulars other than plain drill pipe or tubulars with peripherals such as wire lines, cables, etc., a shear test is a must. There is very little history here and each case is different

### 3.4 Tool Joints and Upset Areas

While the industry is fully aware of the inability of sealing shear rams to shear tool joints, it is unclear as to whether the industry fully appreciates the fact that internal upsets can also be problematic. Going forward, internal upsets as well as tool joints should be taken into account when considering the hang off location, ram space out and resulting shear point of the drill pipe. We do not want to attempt to shear at an internal upset or tool joint; to do so will probably not only be unsuccessful, it will also most likely damage or destroy the shear blades.

There are no established requirements for tool joint or upset length. In fact, it is to the owner's advantage for the tool joint to be longer in length so that it may be reworked a number of times to keep total costs lower. However, this decreases the length of the drill pipe that can be sheared with standard blind shear rams. Many shears are accomplished with the drill pipe hanging off in a set of pipe rams below the shear rams. The variable tool joint lengths require that the distance between the hang off rams and the shear rams be confirmed to ensure the shear ram does not attempt to shear in the tool joint or upset area. Figure 3.3 shows a particular case where the tool joint length from the start of the 18 degree taper to the end of the upset area was 39.50" and there was only 30.50" spacing available between the hangoff rams and the shear rams. This would put the upset area of the tool joint in the shear plane.

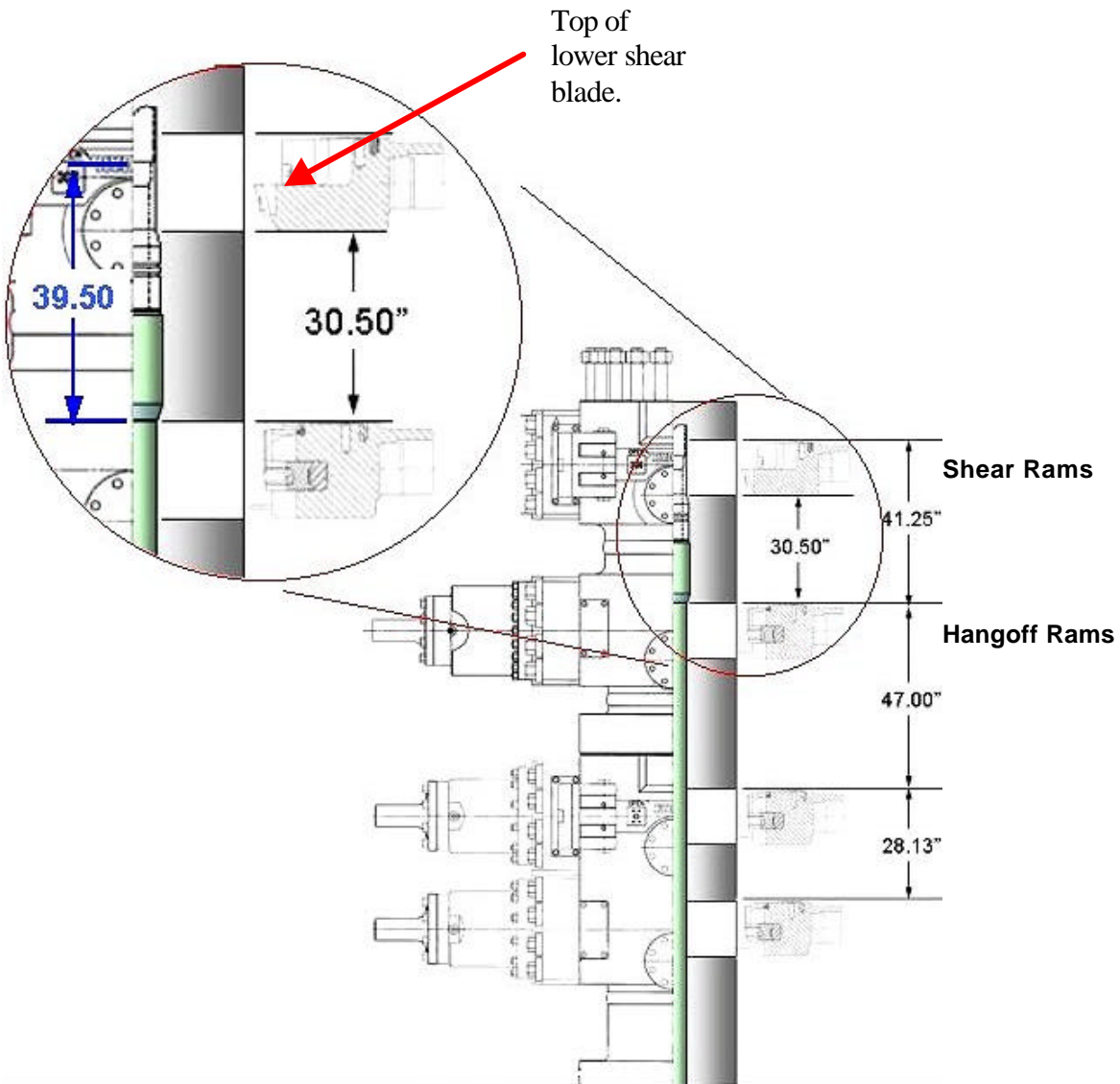

**Figure 3.3 – Tool joint length exceeded the hang off space available.**

Automatically actuated shear sequences where the operator does not have the opportunity to ensure no tool joint is in the shear path pose additional risk. It is for this reason, among others, that newer generation rigs with casing shear rams plan to shear with the casing shears, lift up the drill pipe, and then close the sealing shear rams to seal the bore.

Other variables also affect the ability to shear drill pipe. Internal upsets mentioned above vary and are not precisely known without measuring each joint of drill pipe. Work hardening can affect the ability to shear the pipe.

The best practice would be to standardize the length of tool joints, and/or provide an absolute maximum length of tool joint allowed. Additionally, reliable predictors for pipe stretch should be developed so there is less chance of inadvertently positioning a tool joint opposite the shear rams.

### 3.5 Previous Field Failure

WEST researched known failures to shear and seal and located only the Ixtoc 1 blowout and spill off of the Yucatan peninsula. Undoubtedly, there are more failures that were either not reported well or had minimal exposure. Not included are the known failures to seal during pressure testing since these were repaired prior to the rams being used on the well.



**Figure 3.4** – Ixtoc 1 Blowout and spill

From the internet: “Blowout of exploratory well Ixtoc 1 off of Yucatan in 1979. When workers were able to stop this blowout in 1980 an estimated 140 million gallons of oil had spilled into the ocean. This is the second largest spill ever, smaller only than the deliberate oil spills that ended the Kuwait-Iraq war of 1991. Figure 3.4 borrowed from Office of Response and Restoration, National Ocean Service, National Oceanic and Atmospheric Administration.”

As in other disasters, multiple issues occurred and wrong directions were taken, but the shear rams were activated at one point and did fail to shear. Reportedly, they were pulling the drill string too quickly without proper fluid replacement and the well started coming in. They had no choice but to close the shear rams; unfortunately, drill collars were in the stack and shearing failed. The situation deteriorated from this point. This incident started the development of shear rams that could shear casing and/or drill collars.

### **3.6 Predictive Testing**

Predictive testing is directly related to trend analysis and signature or benchmark testing. For example, should the pressure required to unlock a ram increase from the benchmark, it is indicative of a looming failure—warranting disassembly and inspection/repair. Trend analysis has mainly been used on ram locking systems to determine if they were close to their cycle life limit. Thus the user of a component in need of maintenance and failure is provided with early warning.

Pressure testing the shear rams using locks only to hold them closed is a form of predictive test. Of course, it only demonstrates that the shear rams can properly seal on the surface and is a predictor of a likely successful test if performed on the wellhead. This testing has long been advocated and performed for all the rams, not just shears. With shear rams it is most important.

For shearing applications, the best prediction is the basic reasoning behind this study: know beforehand what maximum force might be required to shear your pipe and plan for it. Therefore, the best predictive test is a shear test on the pipe to be used, with the operating pressure reduced to compensate for the maximum expected hydrostatic and wellbore pressure. This should be followed by a locks-only wellbore test in accordance with API guidelines.

### **3.7 Shear Ram and Ram Lock Configurations**

By the very nature of sealing shear rams, they have less rubber in the packers than fixed bore or variable bore rams. This could make them more vulnerable to sealing difficulties, but generally, shear rams have completely acceptable fatigue life. Sealing is more difficult when pressure testing with only the locks holding the rams closed and any packer shortcomings can exacerbate the problem.

Note: The majority of casing shear rams do not have seals because of the need to maximize the strength of blades for shearing large, thick walled tubulars.

The majority of rigs having Varco Shaffer rams use PosLocks on the shear cavities. UltraLock IIB and IIB with ILF can be used on shear cavities.

Varco Shaffer V shear rams have replaced the Type 72 shear rams in many cases. They have an increased efficiency for shearing, requiring lower shear pressures.

Cameron shear rams can be used with any of their locking systems. The older shearing blind ram, SBR, has one V and one straight blade. It is about 20% less efficient than their newer Double V Shear ram, DVS, which has both blades V shaped.



There are geometric limitations for some of the sealing shear rams. This includes blade width issues and for the Cameron rams, wall thickness issues. Generally, a tubular will flatten during shearing to a width equal to about 1.51 times its diameter (experimentally derived). If this is wider than the blade, shearing is jeopardized. Two of Cameron's shear rams fold over the lower drill pipe fish to clear the sealing area and house the lower fish between the foldover shoulder and the bottom of the upper blade, Figure 3.5. If the wall thickness is too great, the rams may not be able to come together completely and sealing ability is jeopardized, even if there was sufficient force available to shear the tubular.



**Figure 3.5** – Cameron SBR or DVS rams with drill pipe folded over.

### 3.8 Stack Configuration

There are advantages with specific stack configurations when considering drilling conditions such as water depth and modes of disconnect required. The current configuration options for placing shear rams in the stack are:

Only one sealing shear ram (majority of rigs)

Two shear rams - sealing shear ram above casing shear ram

Two shear rams – both sealing shear rams

Three shear rams – upper sealing shear ram above casing shear ram above lower sealing shear ram

Note: The second sealing shear ram increases probability of sealing after a shear. The casing shear ram increases the probability of shearing all varieties of tubulars.

The vast majority of rigs with casing shears place them below the sealing shear rams. The belief is that there is a higher probability of being able to pick up or remove the upper drill pipe fish than for the lower drill pipe fish to be able to go down hole far enough to clear the sealing shear rams. This approach seems the most reasonable.

### 3.9 Shearing with Surface Stacks

The main difference between shearing subsea and on surface is that on surface you do not have to correct for hydrostatic mud weight pressure as you do with subsea stacks. You do have to correct for any kick pressure held under the annular. The biggest issues in shearing with surface stacks are the lack of shear rams on existing rigs and the small piston sizes on most of the surface stacks, 13-5/8" BOPs are prevalent. Many of the 13-5/8" BOPs will have to have their operators replaced with larger units or have boosters added to provide the needed forces.

### 3.10 Pipe Handling and Mux Control System

Additional integration of the pipe handling and BOP MUX control systems could allow the systems to assist the shearing operation. Generally speaking, communication between BOP MUX control systems and the drilling control systems (V-ICIS, et al) is limited to information transfer, namely, reporting control status on one or more of the driller's panels. However, to WEST's knowledge, there is no information that is used as input to decision making on other systems.

Although communication protocols have caused difficulties in this information transfer, there is no fundamental reason the various control systems on a rig could not be integrated. Of critical interest relative to this shear study is removing the variable that the shear rams will close on a tool joint, which is almost certain to result in a failure to shear as well as damage to the shear rams. Those techniques that are currently used by the driller to ensure the rams do not close on a tool joint when preparing to hang off or shear could be utilized, in conjunction with (an) additional sensor(s), in the drilling control system to avoid this catastrophic possibility by moving the drilling string as appropriate.

### **3.11 MMS Requirement**

In Title 30 Mineral Resources; Chapter II – Minerals Management Service, Department of the Interior; Subchapter B – Offshore; Part 250 – Oil and gas and sulphur operations in the Outer Continental Shelf; Revised as of July 1, 2003; the MMS addresses the need for the user to understand if the BOP stack is capable of shearing the drill pipe in the operating conditions. This is found in paragraph 250.416(e), which reads:

#### **“What must I include in the diverter and BOP descriptions?.....**

250.416 (e) Information that shows the blindshear rams installed in the BOP stack (both surface and subsea stacks) are capable of shearing the drill pipe in the hole under maximum anticipated surface pressures.”

### **3.12 Risk and Safety**

As smaller operators with limited appreciation of the risks venture into ever deeper water, the industry’s risk increases. It appears that at least some of the rigs currently in operation have not considered critical issues necessary to ensure that their shear rams will shear the drill pipe and seal the wellbore. Education of those involved should result in increased safety of drilling operations.



## 4 Shear Data from the Manufacturers

### 4.1 Material Properties

Mill certificates provide the drill pipe material properties for a large run of pipe. The actual properties of a given joint of pipe could still vary considerably from the mill cert values. In fact, the properties can vary down the length of a joint of pipe. It is for this reason that the best information from shear tests is material properties obtained from the sheared sample, not just from a mill cert. In conflict to the above experience in the drilling community, Grant Prideco stated that their drill pipe material properties were consistent down the length of the pipe. One of the BOP manufacturers had a different experience in shear tests on drill pipe from an unknown manufacturer. They sheared a single joint of drill pipe at close intervals down its length and had considerable variance in shear forces. This indicated the physical properties of the pipe varied even in a single joint.

Some typical properties for drill pipe, provided by Grant Prideco, can be found in Table 4.1.

**Table 4.1:** Typical material information.

The S-135T would be what we generally refer to as high ductility pipe

<b>Pipe Grade</b>	<b>Yield Strength (ksi)</b>	<b>Tensile (Ultimate) Strength (ksi)</b>	<b>Elongation %</b>	<b>Charpy "V" (ft-lb)</b>	<b>Hardness HRC</b>
S-135 API Typical Values	146	157	21	48	35
S-135 API expected Max	155	165	22	60	38
S-135 API Min Requirement	135	145	13	32	31
S-135 T Typical Values	142	156	21	62	35
S-135 T expected Max	150	165	23	80	38
S-135 T Min Requirement	135	145	13	59	31

Note that while Charpy values increase between S-135 and S135T, the Elongation % does not (except for a one point increase in the maximum). In this study's data, the high ductility S-135 (Charpy values over 59 ft-lb) had Elongation from 18.9% to 21.3% while the standard S-135 (Charpy values below 59 ft-lb) had Elongation from 16.0% to 22.2%. The data was graphed and analyzed, but minimal correlation was found. This result was not as we would have expected. We would have expected a higher elongation to correspond to a higher Charpy value since they both are indicative of the ductility or brittleness of the material. We actually had a relatively small quantity of shear data having both Charpy and Elongation % information, which may explain the anomalous results. Cameron and Varco Shaffer data included Charpy Impact values. Since Hydril does not use Charpy values in their calculations, they provided only Elongation %.

The industry typically refers to the type of pipe by its weight per foot. As a drill pipe manufacturer, Grant Prideco would rather the drilling industry refer to the drill pipe by the actual plain wall thickness (true body nominal wall) instead any of the other weight designations. This would be particularly beneficial for answering shearing questions. There are at least three different weight designations and confusion can abound in determining exactly which pipe is in question. These are: plain end weight, upset to grade weight and adjusted weight per foot. See Table 4.2 for some examples.

**Table 4.2: Grant Prideco examples of the weight issue**

<b>Pipe OD</b>	<b>Plain end weight (lb per ft)</b>	<b>Adjusted weight (lb per ft)</b>	<b>Wall thickness (inch)</b>
5.000	17.91	19.50	.362
6.625	34.00	42.04	.522
6.625	50.40	56.67	.813

The relevant criteria used in calculating shear forces by the drilling community are drill pipe diameter, material and wall thickness. Failure to have the correct wall thickness could lead to an erroneous assumption.

#### **4.2 BOP and Shear Ram Parameters**

There is some question whether the BOP size makes a difference in the shear forces. It is understood that there could be a variance between some BOPs. At least one BOP manufacturer believes that the size or model of BOP does not matter, only shear ram type matters, meaning that the force required to shear with in a 13 5/8” BOP is the same as in a 18 3/4” BOP as long as the shear ram design is the same. This study assumes that the BOP size is not a factor and instead focuses on shear force. For further information, see Section 4, Statistical Analysis.

There are two basic types of sealing shear ram designs: single and double “V” blades – rams with double “V” blades appear to have 15% to 20% lower shear forces than single blade designs. The data received primarily included shear rams having both blades “V” shaped, see Figure 4.1. The two data points from shear rams that did not have both blades “V” shaped were excluded from statistical consideration.

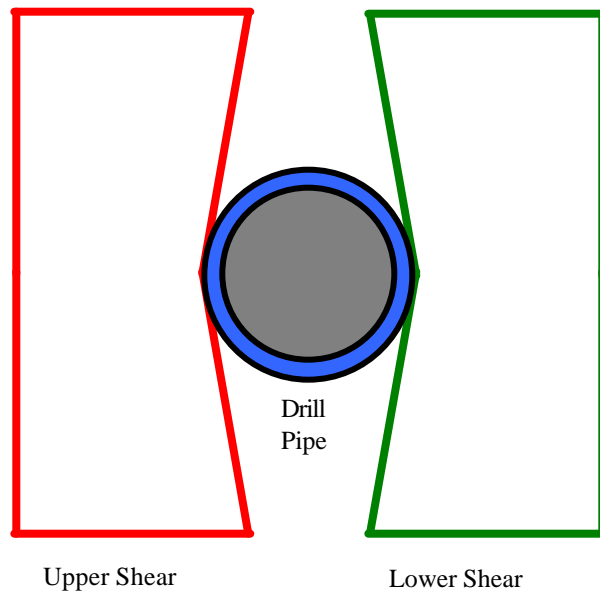

**Figure 4.1: View Looking down the wellbore at the shear blades in contact with the drill pipe.**

### **4.3 Rationalization of Data**

The information received from the BOP manufacturers was edited during this process and during the statistical analysis as follows: (Reference Attachment 4.1)

- Data points from casing shear rams deleted so that only sealing (blind) shear ram data was included
- Included only shears using shear rams with both blades having a “V” shape
- Removed all non-drill pipe tubulars (casing, tubing, shear joints, etc.) so that only drill pipe was studied.
- Deleted data if the drill pipe wall thickness could not be verified by API Specification 5D or Grant Prideco.
- Deleted data if the material properties were outside of API requirements. (Slight discrepancies were allowed)

### **4.4 Differences Between Manufacturers**

Some of the main differences between the BOP manufacturers are: Varco Shaffer and Cameron record and supply Charpy impact values while Hydril only uses and supplies Elongation %. Cameron states that their shear pressures are basically unaffected by the Charpy values, or the ductility of the pipe and they use the Distortion Energy Theory equation for pure shear with good results. This equation uses .577 times yield strength to obtain the shear yield strength. Varco Shaffer states that this same shear equation with ultimate tensile strength substituted for yield strength works better for them. Use of the ultimate strength increases the calculated shear force since the ultimate strength is always greater than the yield strength. Hydril did not supply their shear force equation but say that they include the material Elongation % in their calculations to improve the accuracy.

### **4.5 Charpy Impact vs. Elongation**

Both Charpy impact values and Elongation % are indicators of the material’s ductility or brittleness. Prior to this study WEST had assumed it was best to use Charpy values in order to understand if we were dealing with ductile or brittle material. Upon reviewing the supplied data, it was noted that the Charpy values were reported at different temperatures and from different sample sizes, making direct comparisons difficult, or impossible. At the same time, Elongation is performed at room temperature according to a standardized test. Due to the great variability in Charpy data, it appeared that using Elongation would be more consistent and preferable. Therefore, the majority of the work in graphing the data and trying to determine a possible shear equation utilized Elongation. The irregularity here is as stated above, the pipe material with higher Charpy values does not appear to have correspondingly high Elongation requirements.

## 4.6 BOP Available Shear Force

Examples of BOP operators and maximum closing forces at 2700 psi and 3000 psi are contained in Table 4.3. This information is useful in understand which drill pipe can be sheared in the various BOPs.

**Table 4.3: BOP Manufacturer Information**

<b>Manufacturer, BOP and Operator Type</b>	<b>Close Area (sq. in.)</b>	<b>Force (lb.) at 2,700 psi</b>	<b>Force (lb.) at 3,000 psi</b>
Cameron 13-5/8" 10K U w/ LB shear bonnets and boosters	224.0	604,800	672,000
Cameron 18-3/4" 10K U	228.0	615,600	684,000
Cameron 18-3/4" 15K UII w/ Operating cylinder	330.0	891,000	990,000
Cameron 18-3/4" 15K TL w/ ST Locks	239.0	645,300	717,000
Cameron 18-3/4" 15K TL w/ RamLocks	255.0	688,500	765,000
Cameron 18-3/4" 15K TL w/ RamLocks and boosters	508.0	1,371,600	1,524,000
Hydril 14.25"	159.5	430,650	478,440
Hydril 15"	188.7	509,490	566,070
Hydril 19"	283.5	765,450	850,590
Hydril 20"	314.2	848,340	942,480
Hydril 22"	380.1	1,026,270	1,140,390
Shaffer 14"	153.9	415,530	461,814
Shaffer 15.5"	188.8	509,760	566,453
Shaffer 22"	380.3	1,026,810	1,140,778
Shaffer 10" w/ 10" booster	155.0	418,500	465,017
Shaffer 14" w/ 14" booster	293.7	792,990	881,069
Shaffer 14" w/ 16" booster	340.8	920,160	1,022,441
Shaffer 14" w/ 18" booster	394.2	1,064,340	1,182,662

## 4.7 Data Spreadsheet and Graphs

The full set of data can be found in Attachment 4.1, “BOP Manufacturer Shear Information”, 5 pages. The data was edited to include: only drill pipe; only pipe dimensions as could be verified in API 5L or using information provided by Grant Prideco; only sealing shear rams with double V blades (Casing shear ram data was excluded); and only material data meeting API requirements. Blank cells in the spreadsheet mean that no data was provided by the manufacturer. The data is sorted by Material Grade and drill pipe cross-sectional area. Note that material yield data was not provided for 18 of the inputs and material ultimate strength data was not provided for 3 of the inputs. This will be apparent when viewing some of the graphs that follow since there are gaps in the graphed lines for the calculated shear forces.

The explanation of each column of the spreadsheet follows:

#	Sample number (counter)
Dia	Drill pipe diameter in inches
Wall	Drill pipe wall thickness in inches
PPF	Pounds per ft., weight of the drill pipe
Material Grade	Drill pipe Material Grade, indicates yield strength
BOP Mfg.	BOP and Shear ram manufacturer
BOP Bore	BOP wellbore diameter in inches
Working Pressure	BOP wellbore pressure rating in psi
BOP Type	Model of BOP or other designation as provided by manufacturer
BOP Close Area	Piston closing area in square inches
Shear Ram type	Shear Ram type
Yield Strength	Yield strength of sheared sample or from drill pipe certifications, in psi
Ultimate Tensile Strength	Ultimate tensile strength of sheared sample or from drill pipe certifications, in psi
Charpy, CVN	Charpy impact value of sheared sample or from drill pipe certifications, in ft-lb
Elongation %	Elongation % of sheared sample or from drill pipe certifications
Hardness RC	Rockwell hardness of sheared sample or from drill pipe certifications, C scale
Actual Shear Pressure	Pressure at which pipe sheared in psi
Actual Shear Force	Force at which pipe sheared (Actual pressure times BOP close area)
Shear force using Yield Calculation	Force to shear from the calculated using the Distortion Energy Shear Equation and the material yield strength
Shear force using Ultimate Calculation	Force to shear from the calculated using the Distortion Energy Shear Equation and the material ultimate tensile strength
Source of Information	Varies according to information supplied: date or engineering report number
Comments	As needed, mainly the varying Charpy Impact test temperatures

**Attachment 4.2:** Shear forces and Elongation – this graph includes the actual shear force, calculated shear forces and elongation all on one graph. The calculated shear forces use the Distortion Energy Theory shear equation, using Yield as normal, but also substituting Ultimate to add a safety factor –

$$F = 0.577 \times S_Y \times \text{Area}$$

or

$$F = 0.577 \times S_U \times \text{Area}$$

Where:

$S_Y$  = drill pipe material yield strength (psi)

$S_U$  = drill pipe material ultimate strength (psi)

Area = cross-sectional area of the drill pipe. (Sq Inches)

Shear Forces are on the left hand Y axis (Actual, calculated using material yield strength, calculated using material ultimate strength). Elongation % is on the right hand Y axis. The input data has been sorted by drill pipe grade putting the E-75, G-105 and S-135 in groups from left to right. Within each grade, the data is sorted by cross-sectional area, least to greatest.

There are 49 actual shear forces above the shear force calculated using yield strength and there are 24 actual shear values that were above the force calculated using ultimate strength. The Elongation graph line can only be used to see trends – higher Elongation should mean higher shear forces, and vice versa. The graph does show that the shear equation using ultimate strength is more useful in providing a cushion since it is exceeded fewer times. There will be further discussion on this later in the report.

**Attachment 4.3:** Same as the previous graph except S-135 drill pipe only. There are 14 actual shear forces above the shear force calculated using yield strength and there are 2 actual shear values that were above the force calculated using ultimate strength. The Elongation graph line can only be used to see trends – higher Elongation should mean higher shear forces, and vice versa. The graph does show that the shear equation using ultimate strength is again safer from a not to exceed perspective.

**Attachment 4.4:** Elongation % on the Y axis versus Charpy Impact values on the X axis. This shows the trend of Elongation for a given Charpy. The two separate groupings also clearly indicate the difference between the standard S-135 and the high ductility S-135. Even though they are clearly grouped, we still would have expected the high ductility group to have higher Elongations corresponding to the higher Charpy values.

#### **4.8 Data Correlation**

Numerous attempts were made to manually correlate the data and determine a shear predictor equation that matched the data as provided. After manual, intuitive attempts did not provide a satisfactory equation, we turned to computer based statistical analysis to both understand the data and to predict shear force. Regardless of what was assumed to be the case, it was determined best to allow the statistical analysis to provide the best fit equations. The results of this work can be found in Section 5.

As noted elsewhere, shear forces calculated using the Distortion Energy Theory shear equation, as used by Cameron, are close to what the data would predict, but have sufficient error so as to not be acceptable. Substituting the material's ultimate strength for the yield strength, as Shaffer does, provides fewer missed data points, but at the expense of extremely high predictions in some cases (over 170% above actual).

As will be seen in the next section when the data is adjusted statistically using the same Distortion Energy Theory shear equation and the Elongation %, an equation is provided with a much better fit to the actual data. When two standard errors are applied, the equation is correct for 129 of the 135 data points for S-135 pipe, or 95.6%. This is very close to the statistically predicted 97.725% accuracy. See Section 5, attachment 5.1.

## 5 Statistical Analysis

### 5.1 Rationale of Statistical Analysis

WEST statistically evaluated the 214 drill pipe shear data points (Attachment 4.1) in an attempt to understand when we are at risk of being unable to shear pipe. The data is for E-75, G-105 and S-135 drill pipe and all represent sub-sets that correlate differently. Each was examined statistically to understand the confidence in shearing for each type pipe – with a concentration on S-135. See the Table 5.1 for a summary of the data and a comparison to the Distortion Energy Theory Shear Equation.

**Table 5.1: Summary of the Data and Comparisons**

<b>Drill Pipe Material</b>	<b>Total Actual Shear Data points</b>	<b>Data points above force using Distortion Energy Theory (using yield strength)</b>	<b>Percentage Actual Shear over Distortion Shear (yield)</b>	<b>Data points above force using Distortion Energy Theory (using ultimate strength)</b>	<b>Percentage Actual Shear over Distortion Shear (ult.)</b>
E-75	33	26	78.8	19	57.6
G-105	46	9	19.6	3	6.5
S-135	135	14	10.4	2	1.5
All Grades	214	49	22.9	24	11.2

All data was separated by drill pipe material to determine trends or differences. From this data, as the strength of the material increased, the Distortion Energy Theory missed on the low side less often. As the strength of the material increases, the ductility generally goes down, i.e., the lower strength E-75 is typically more ductile whereas the higher strength S-135 would be expected to be more brittle. Higher ductility material, for the same yield strength, generally requires more force to shear – or, lower ductility, brittle material is easier to shear.

The Distortion Energy Theory shear equation uses yield strength, not ultimate strength. By substituting ultimate strength in this equation, a multiplier is in effect being added. Below we further evaluate how well the Distortion Energy Theory shear equation works as a predictor of shear forces. It must be understood that the industry’s need for a calculated shear force that is not exceeded means that, in effect, there must be a large safety factor included. This is evaluated statistically below.

The statistical analysis of the data resulted in charts and graphs that address the following:

- How well the Distortion Energy Theory shear equation correlates with actual shears.
- Whether or not Elongation % correlates with actual shears.
- Understand distribution of shear results (shapes—histograms predict probabilities).
- Predict shearing force given yield strength (same as via Distortion Energy Theory) and Elongation %.



We wanted to understand what the data looked like. Did it fit a bell curve (normal distribution curve) or something different? Histograms were produced, which provided information as to how the shears were distributed. This was necessary to understand the viability of using the data to predict future shears.

To predict shears, we used multiple regression analysis (having Distortion Energy Theory Shear Force and Elongation % as independent variables). Note that instead of using Distortion Energy Theory Shear we could have just used yield strength (in psi). The results from the regression analysis would have been exactly the same.

Critical variables are as follows:

- Type of pipe. S-135, G-105 or E-75.
- Material Yield Strength.
- Material Ultimate Tensile Strength (Tensile Strength).
- Elongation %
- Drill Pipe outside diameter
- Drill Pipe Wall thickness.
- Force to shear. The shear pressure multiplied by the BOP closing area.

## 5.2 Histograms for better understanding of the data

The data collected was examined in several ways. We examined all shear data collected, see Graph 5.1 and Table 5.2.

**Graph 5.1**

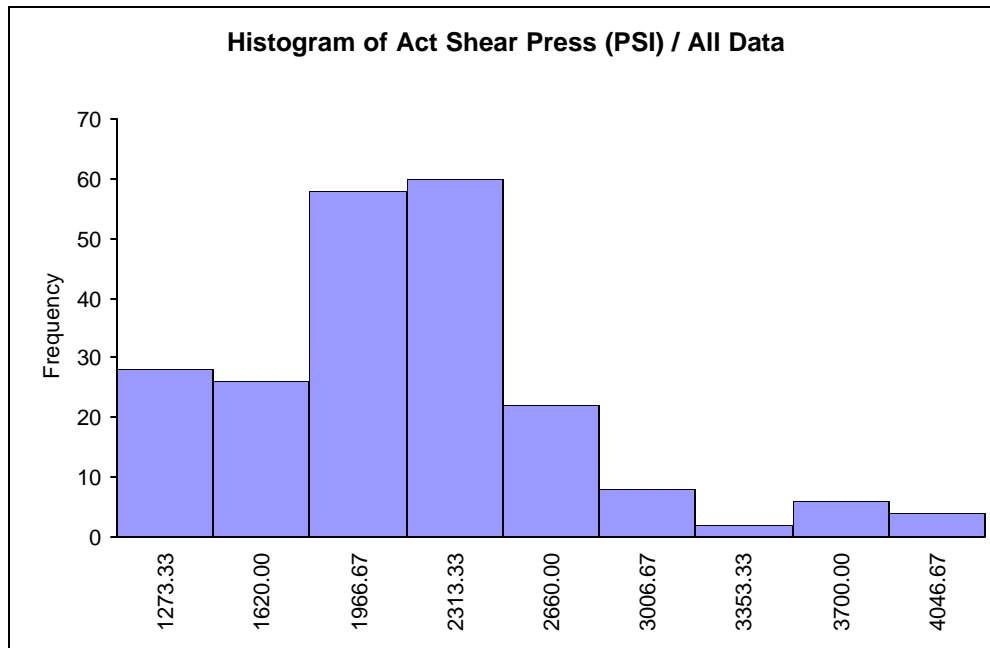

**Table 5.2**

<b>Act Shear Press (PSI) / Data Set #1</b>						
<b>Histogram</b>	<b>Bin Min</b>	<b>Bin Max</b>	<b>Bin Midpoint</b>	<b>Freq.</b>	<b>Rel. Freq.</b>	<b>Prb. Density</b>
<b>Bin #1</b>	1100.00	1446.67	1273.33	28	0.1308	0.00038
<b>Bin #2</b>	1446.67	1793.33	1620.00	26	0.1215	0.00035
<b>Bin #3</b>	1793.33	2140.00	1966.67	58	0.2710	0.00078
<b>Bin #4</b>	2140.00	2486.67	2313.33	60	0.2804	0.00081
<b>Bin #5</b>	2486.67	2833.33	2660.00	22	0.1028	0.00030
<b>Bin #6</b>	2833.33	3180.00	3006.67	8	0.0374	0.00011
<b>Bin #7</b>	3180.00	3526.67	3353.33	2	0.0093	0.00003
<b>Bin #8</b>	3526.67	3873.33	3700.00	6	0.0280	0.00008
<b>Bin #9</b>	3873.33	4220.00	4046.67	4	0.0187	0.00005

The above table and graph include all shearing pressure (psi) points for the data. This pressure is that pressure acting on the piston to cause the force that shears the pipe. The shearing pressure data points were sorted into bins and then graphed. For example, in the first bin (between 1100 psi and 1446.67 psi) there were 28 data points. As can be seen in the graph, this data does not fit a standard bell curve and thus is not normally distributed. A histogram with sufficient points should correspond closely to an underlying probability curve. The shearing pressure (psi) is, of course, directly related to the closing area (square inches) of the BOP; therefore, those BOPs with the largest closing area require lower shear pressures and vice versa.

Next we examined the data by type of pipe. This data (not included herein) was inconclusive because it was quite dependent upon the closing area of the shear BOP. The closing pressure data by type of pipe and by manufacturer was examined. All was as expected here, with the largest shear BOP closing areas having the lowest shear pressures. This data is not included herein.

To eliminate any problems with the multiple closing area sizes, we moved the focus to force rather than pressure. The following graphs provide shear force distributions for all pipe and by type pipe, see Graphs 5.2, 5.3, 5.4, and 5.5.

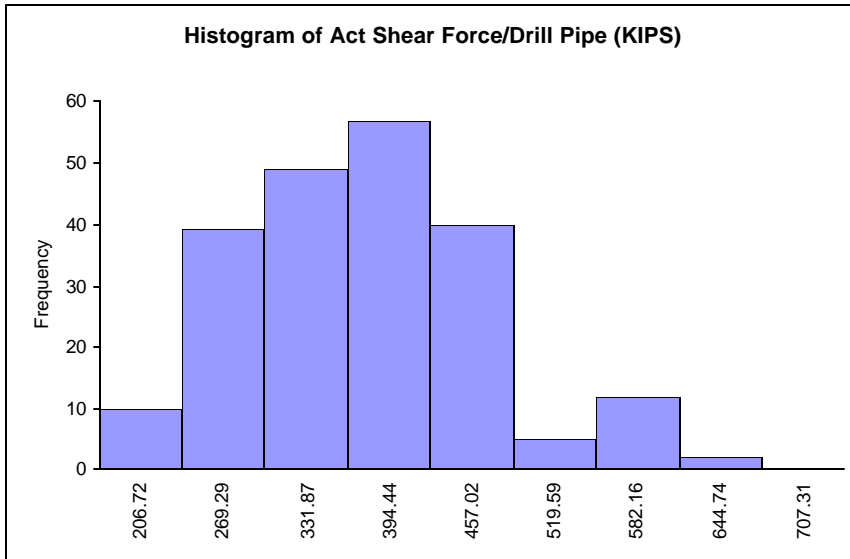

**Graph 5.2**

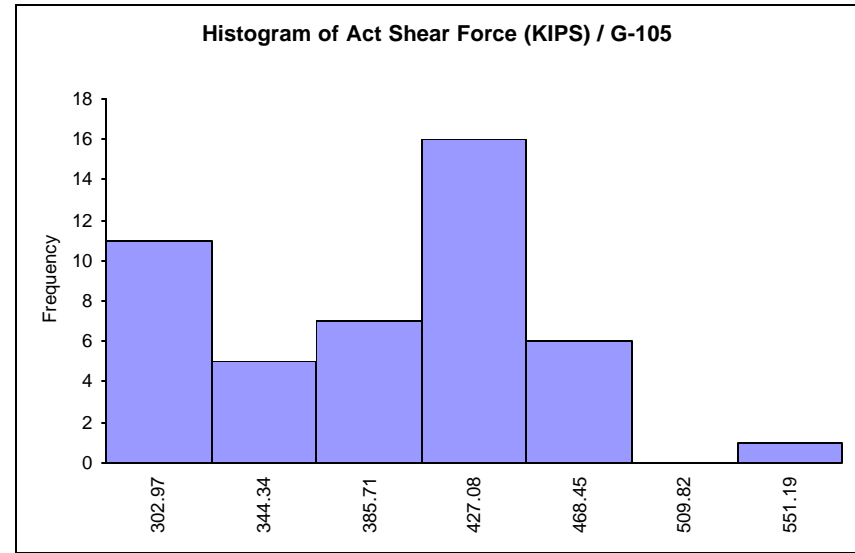

**Graph 5.3**

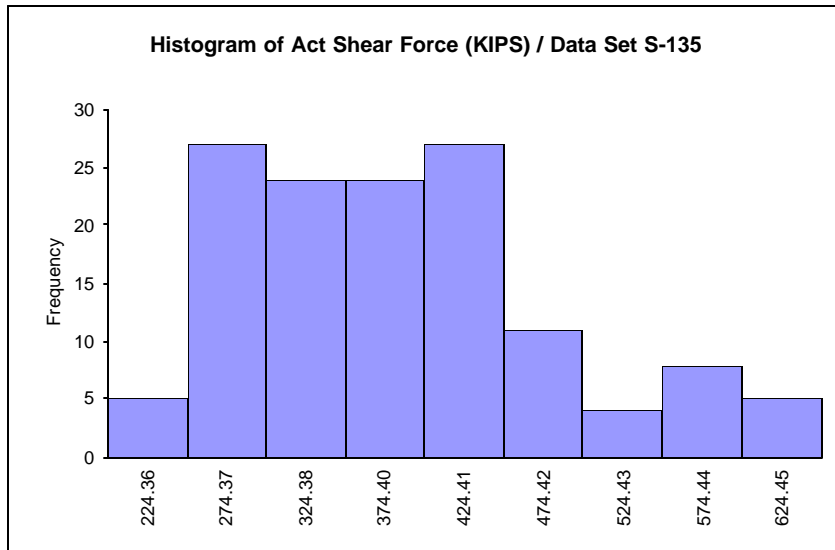

**Graph 5.4**

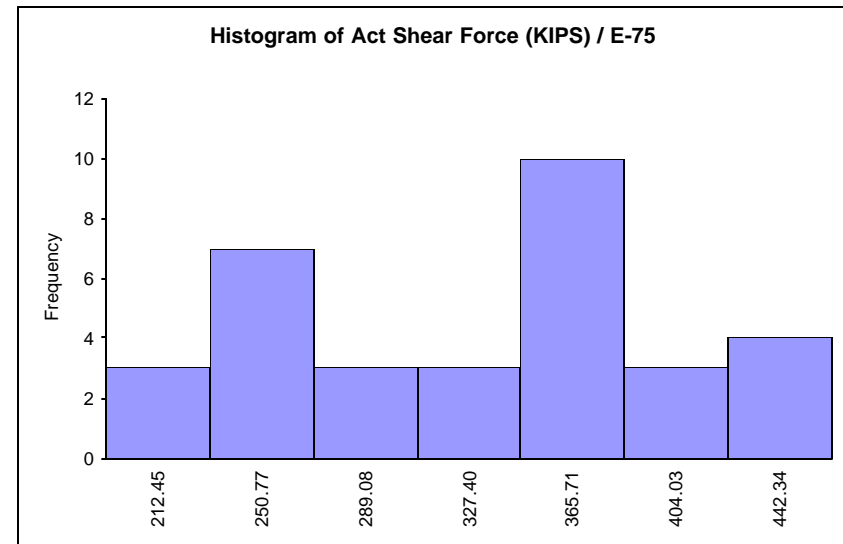

**Graph 5.5**

The above distribution of forces required to shear are quite scattered as can be seen. They do not fit a bell curve or normal distribution.

In an attempt to get a set of data more closely concentrated, we examined specific datasets having the same type of pipe, same weight per foot and same diameter. The histograms developed also did not fit a bell curve (were not normal)—in fact they too were quite scattered. Graphs 5.6, 5.7 and 5.8 are included below.

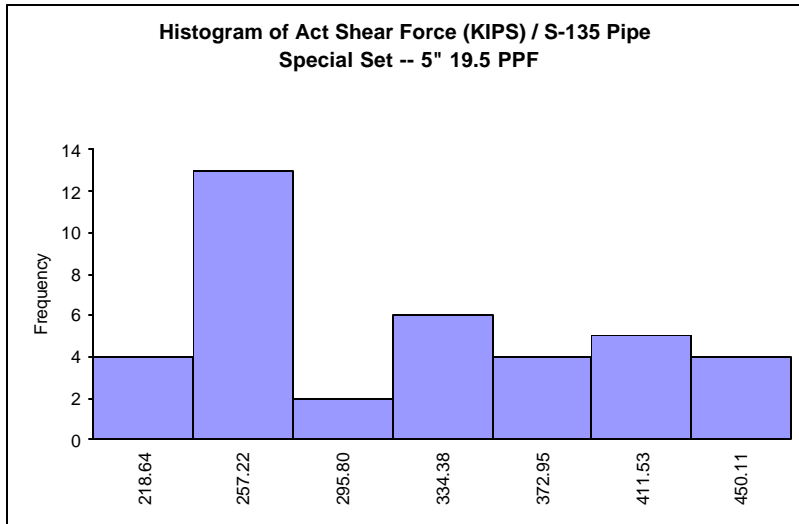

**Graph 5.6**

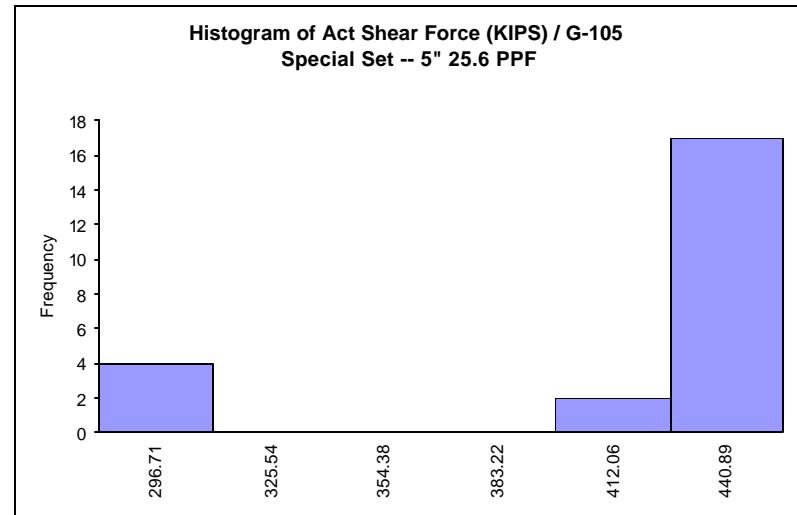

**Graph 5.7**

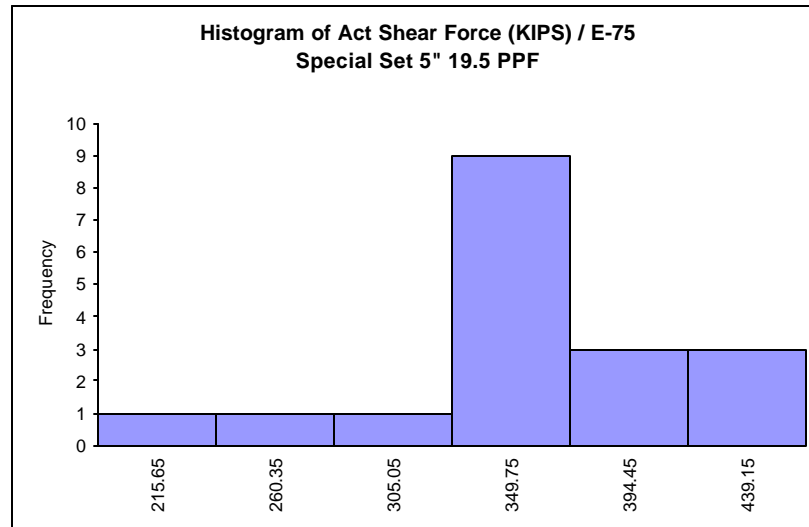

**Graph 5.8**

The industry has used the Distortion Energy Theory shear equation to determine a force at which pipe will shear. We wanted to evaluate how close that theory is to the actual shear points in our data. Graph 5.9 below displays the difference between the actual shear force and the estimated shear force using the Distortion Energy Theory shear equation.

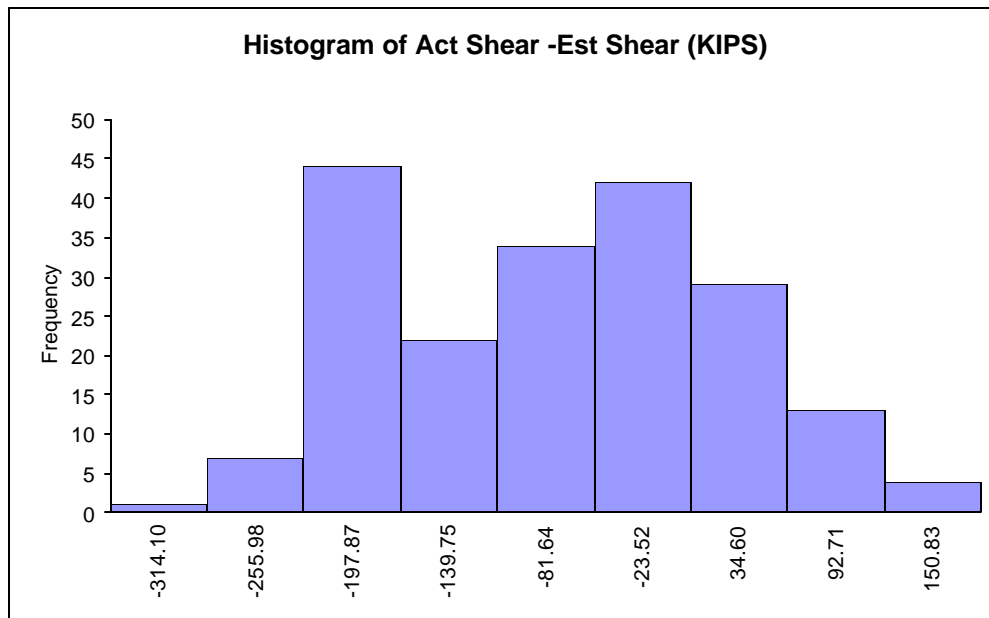

**Graph 5.9**

More specifically: Actual Shear Force minus Estimated Shear Force calculated using the Distortion Energy Theory shear equation (using yield strength) was plotted for all 214 shears. The graphic distribution appeared closer to being a normal distribution (bell curve) than previous curves. The mean of the differences plotted was  $-78.7$  KIPS. In other words the Distortion Energy formula is on the average  $78.7$  KIPS higher than that seen from the data collected. The standard deviation is  $102.68$  KIPS. Assuming normalcy (which it isn't), to have a 90% confidence that the pipe will shear, a safety factor of 1.28 times the standard deviation should be added. To have a 95% probability, 1.65 times the standard deviation should be added.

To further explain the above, find the graphic below which illustrates the issues discussed. For a normal distribution, there is a 68.27% probability that a point (or shear in our case) will be within one standard deviation on either side of the mean. For two standard deviations on either side of the mean, there is a 95.45% probability that a point (or shear) will be in that area. Since we are only interested in the high side and not the low, two standard deviations for our purposes increases the percentage up to 97.725%. For Regression Analysis purposes (discussed later in this section) the StErr of Estimate is analogous to standard deviation.

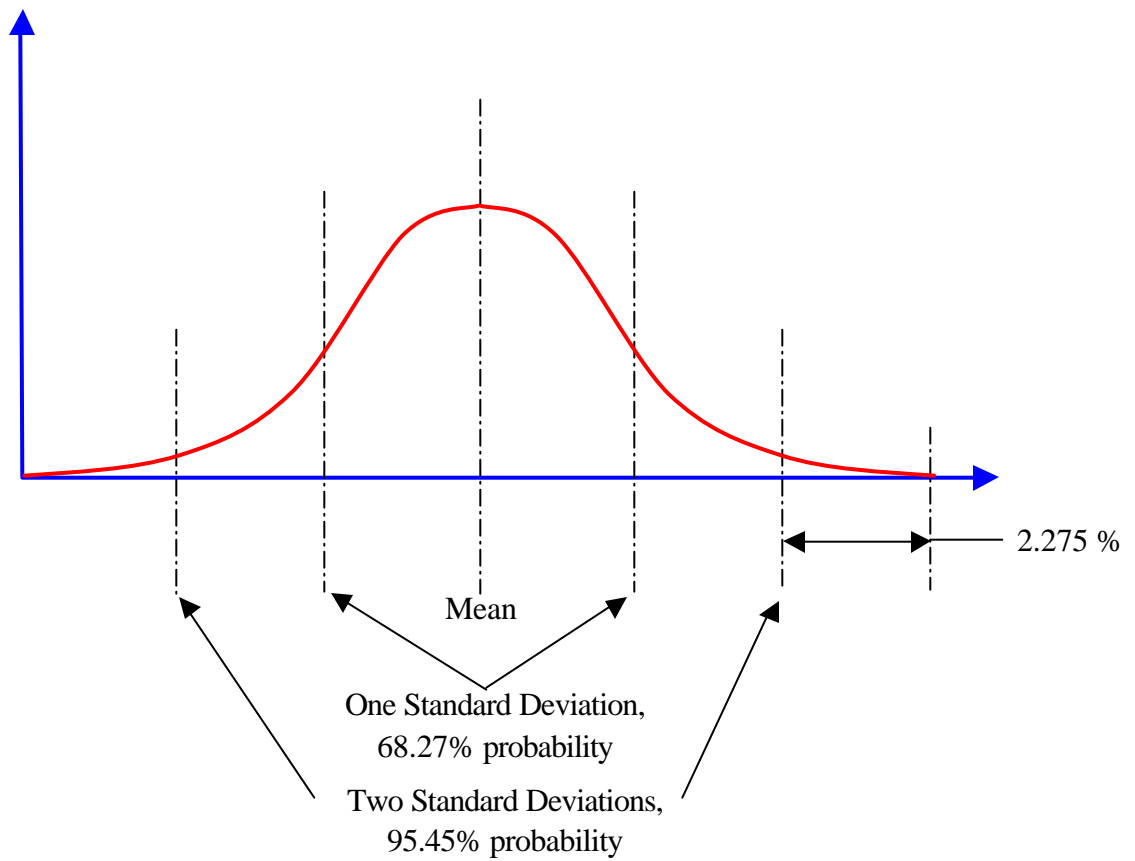

**Example of a Normal Distribution**  
(Not based on actual data)

A Chi-Square test was run on the data to test for normality – the results are displayed in Graph 5.10 below.

**Graph 5.10**

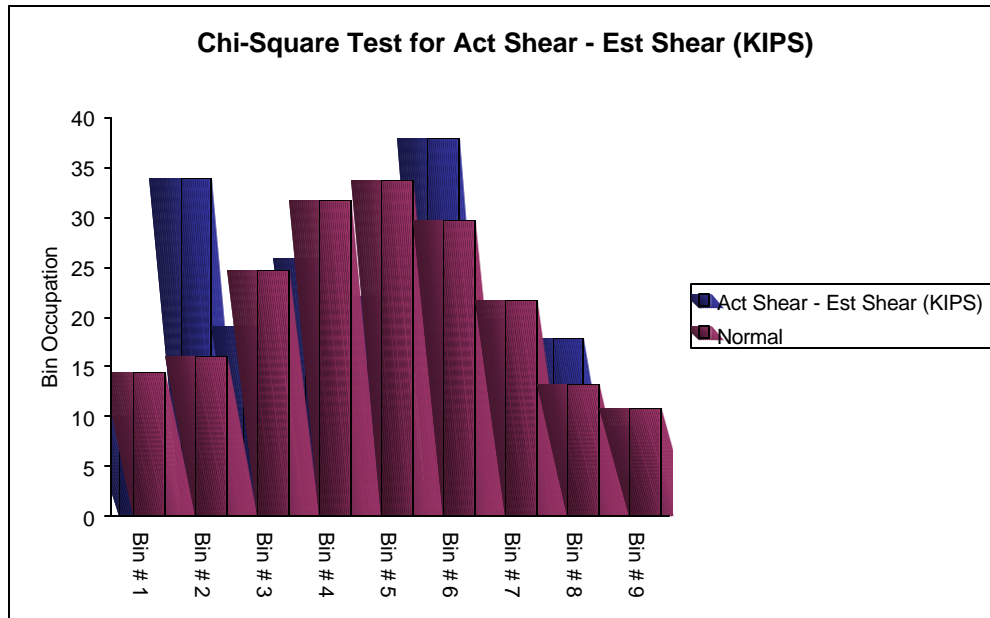

Many statistical procedures assume (including the discussion regarding standard deviations above) that a variable is normally distributed; therefore, it is appropriate to determine/address whether data is normally distributed or not. To address whether our data of the Actual Shear minus Distortion Energy calculated shear was normal, the Chi-Square goodness-of-fit test was performed on the data. The results determined a Chi-Square of 32.41 and a P-Value of  $< 0.0001$ ; these numbers are such that a normal distribution cannot be assumed. A further test called the Lilliefors test was run on the data, which also concluded that the data was not normally distributed. None-the-less, the assumption of normalcy allows us to better understand the nature of our data.

### 5.3 Regression Analysis

Next we used Linear and Multiple Regression Analysis to aid in development of a formula that could be used as a predictor of shear values. The analysis is an iterative process that minimizes the square of the difference between Calculated Fit (shear force) and Actual shear force. The Calculated Fit shear value established in this fashion must have a safety factor to provide the desired “insurance” that the pipe will shear. The table that follows provides the results of analyzing the data based on actual shear force, predicted shear force (using Distortion Energy Theory shear equation) and Elongation %. The ideal for the industry would be a shear force predictor that would be successful for shearing the pipe in question close to 97% of the time.

### Results from Regression Analysis Using Least Squares Method

The table below provides the results obtained by setting the following variables up:

Y = Estimated shear force

C = Constant

X1 = Predicted shear using Energy Distortion Theory shear equation

A = Multiplier on X1 developed from Regression Analysis

X2 = Elongation %

B = Multiplier on X2 developed from Regression Analysis

R Square = See Glossary of Terms

StErr of Estimate = See Glossary of Terms

In general the formula used is as follows:

$$Y = C + A \times X1 + B \times X2$$

The analysis was done for all pipe and for the three different types of pipe (E-75, S-135, and G-105).

**Table 5-3**

	C	A	B	R Square	St Err	Ind. Var.
All Pipe:						
	35.28	0.427	6.629	0.231	75.15	Ind. Var. = Both
	206.94	0.369		0.207	77.47	Ind. Var. = Calc. Shear
E-75 Pipe:						
	-234.03	-0.318	25.357	0.359	62.03	Ind. Var. = Both
	959.05	0.581		0.015	105.00	Ind. Var = Calc. Shear
	-145.53		18.453	0.342	61.84	Ind. Var = Elongation %
G-105 Pipe:						
	181.33	0.396	2.035	0.121	62.89	Ind. Var. = Both
	209.86	0.414		0.120	62.18	Ind. Var. = Calc. Shear
S-135 Pipe						
	-35.11	0.630	4.489	0.300	76.69	Ind. Var. = Both
	57.61	0.636		0.298	78.25	Ind. Var. = Calc. Shear

In other words, multipliers of predicted shear force and Elongation % (the independent variables) as predictors of shear force (dependent variable) were developed.



The first set of curves examined for regression analysis purposes was for “all pipe.” A multiple regression was performed which included using the two independent variables stated above. For this data the  $r^2$ , as can be seen from the chart, was 0.2314. In other words 23.14% of the variation is explained by the equation developed. For all pipe, the equation developed from the two variables as can be seen in the chart above was:

$$\text{Calculated Fit (Shear Force)} = 35.28 + 0.427 \times (\text{Distortion Energy Shear Calculation}) + 6.629 \times (\text{Elongation}\%)$$

The StErr for this curve is 75.15. Thus if you drew lines parallel to the above line which were plus/minus 75.15 and plus/minus two times 75.15 you would have an area that would contain 68.27% and 95.45% of the points respectively, assuming our sample is sufficiently large.

For this data, three Graphs 5.11, 5.12 and 5.13 of the data have been included below. The Graph 5.11 relates Calculated Fit to Actual Shear Force. Graph 5.12 shows Calculated fit as a function of Distortion Energy Theory shear force using Yield, while Graph 5.13 shows Calculated Fit vs. Elongation %. A table with the data used for the statistical analysis is included in the Appendix as item A-1. This table was included to allow the reader to understand how the numbers were calculated. There are only 196 data points here rather than 214 since 18 points did not include the material yield information, and therefore could not have a Distortion Energy Theory shear force calculation.

**Graph 5.11**

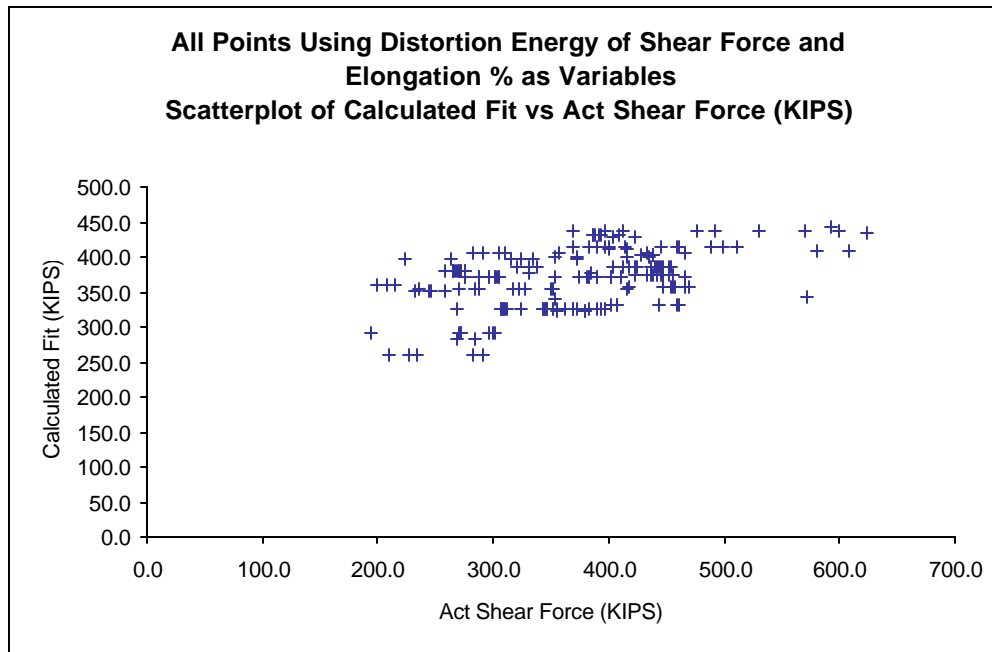

Highest shears were not predicted (and must have a safety multiplier to include a larger % chance of shearing). The Calculated Fit was the most likely fit and as such included no safety factor.

**Graph 5.12**

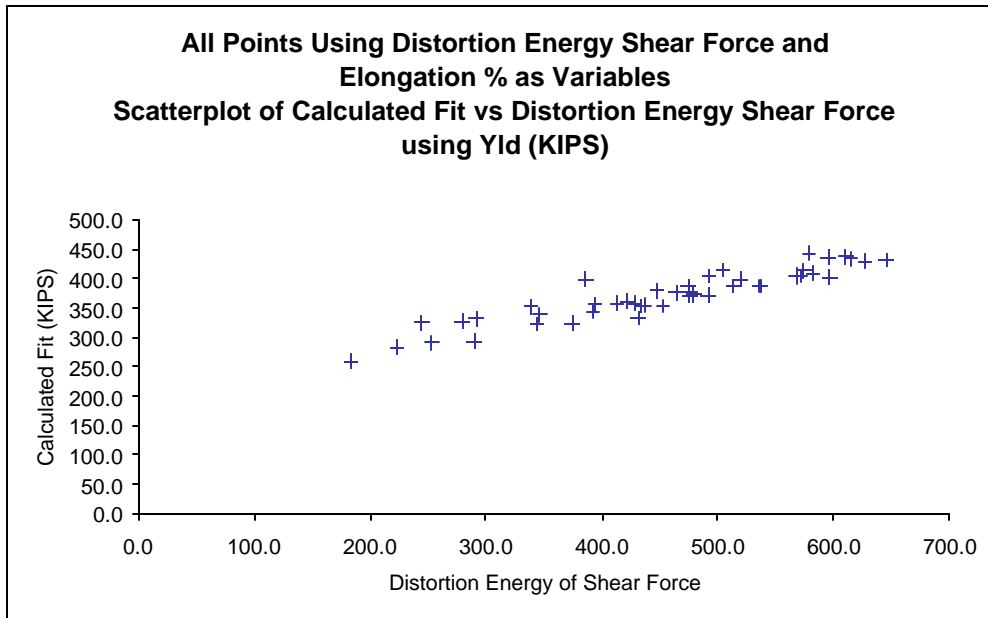

The Calculated Fit as a function of Distortion Energy Theory Yield was basically a straight line with Elongation % having minimal effect on the line.

**Graph 5.13**

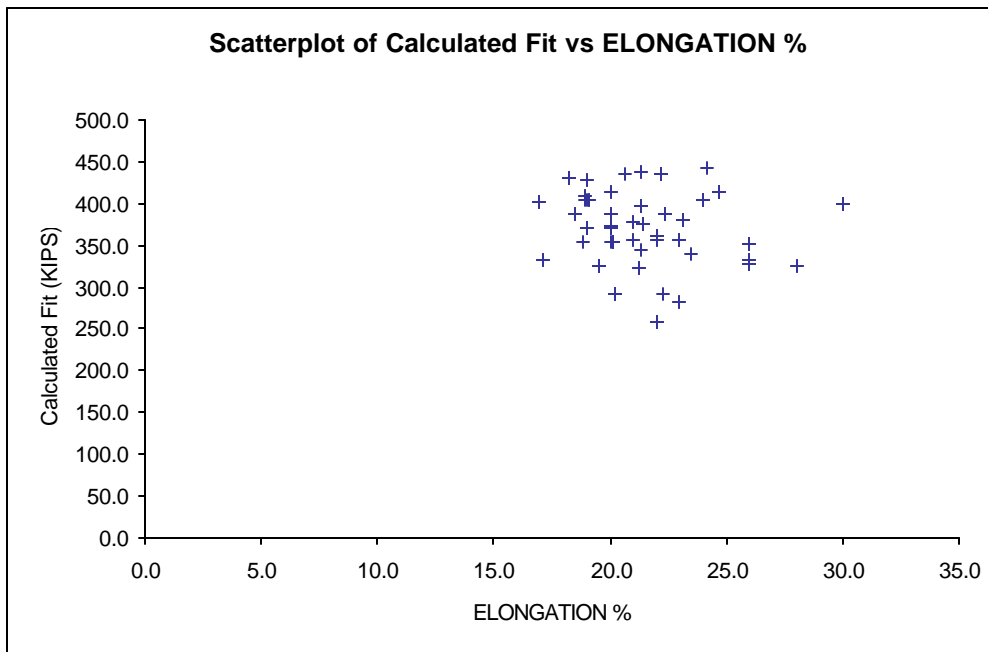

Scatterplot of Calculated Fit vs. Elongation % exhibits the nature of Elongation %. As can be seen it does not result in a consistent pattern. Thus the Calculated Fit does not gain as much accuracy from Elongation % as it does from Distortion Energy Calculated Shear Force.

The second series of charts examined was for all pipe also but included only Distortion Energy Shear Force as an independent variable. A linear regression was performed. For this data the  $r^2$ , as can be seen from the chart, was 0.2072. In other words, this single variable was not as good in explaining the actual shear as the one above. The equation developed from the two variables was:

$$\text{Calculated Fit (Shear Force)} = 206.93 + 0.369 \times (\text{Distortion Energy Shear Calculated})$$

The StErr for this curve is 77.47. On the Graph 5.14 (Actual Shear Force vs Shear Force Calculated using the Distortion Energy Theory shear equation) we have drawn lines parallel to the Best Fit line which are plus 77.47 and plus two times 77.47 to illustrate the 68.27% and 95.45% probabilities. It was shown here because the linearity makes for a clear illustration, and, as can be seen, two StErr of Estimate errors is actually good for 97.2% of the data.

**Graph 5.14**

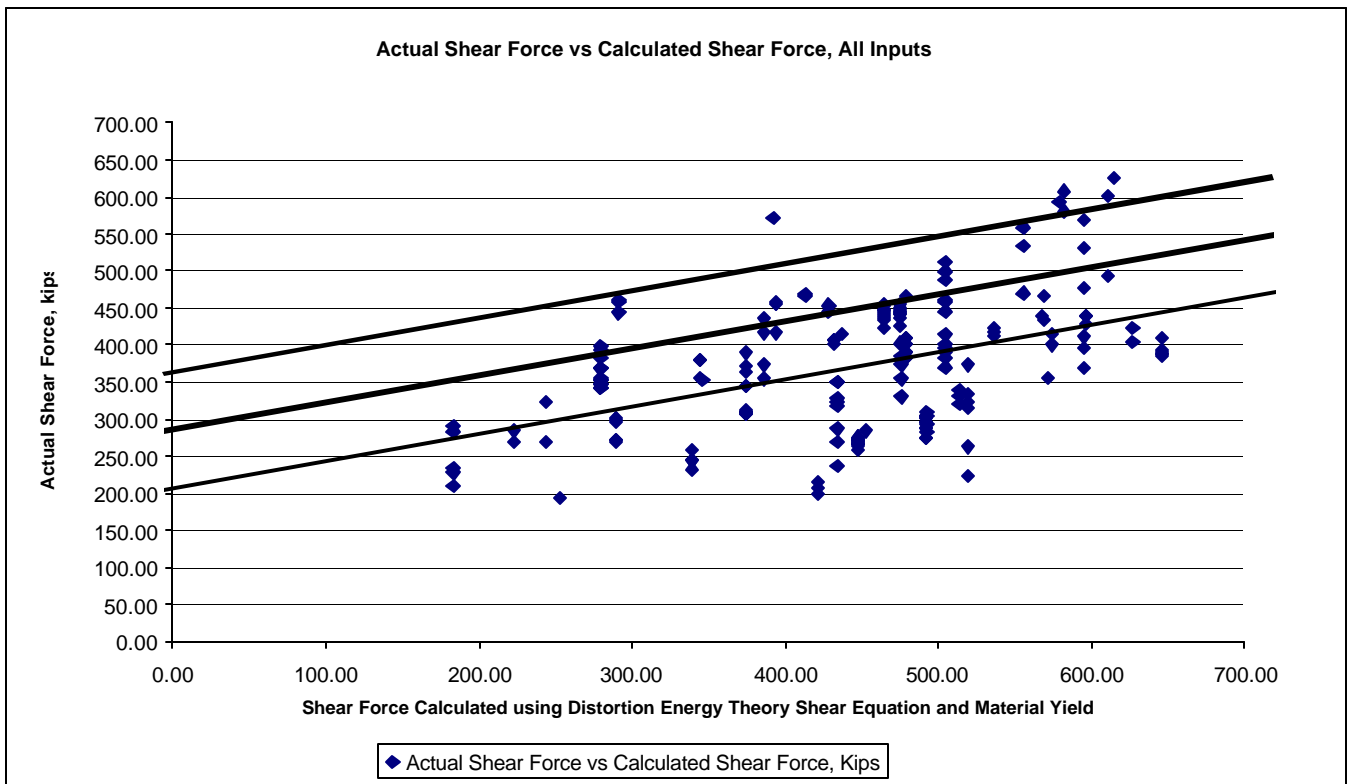

The lower line is the Calculated Fit of the data. The middle line is the Calculated Fit plus one StErr of Estimate error of 77.47, while the upper line is the Calculated Fit plus two StErr of Estimate errors. Two StErr of Estimate errors plus the Calculated Fit line should provide 97.725% probability that the actual shear will not be exceeded. We have 214 inputs with 6 above the upper line for 97.2% accuracy.

It is sufficient to say that the G-105 pipe had a low  $r^2$ , indicating that the data fit the regression curve very poorly. The G-105 graphs were produced and reviewed but not included herein since there is little G-105 pipe in use today.

The next set of curves created by regression analysis was for E-75 pipe. A multiple regression was performed. For this data the  $r^2$  using the two independent variables was 0.359, the highest of all reviewed.

Calculated Fit (Shear Force) =  $-234.03 - 0.318 \times (\text{Distortion Energy Shear Calculated}) + 25.357 \times (\text{Elongation}\%)$

The StErr of Estimate for this curve is 62.03. The data is included below.

**Graph 5.15**

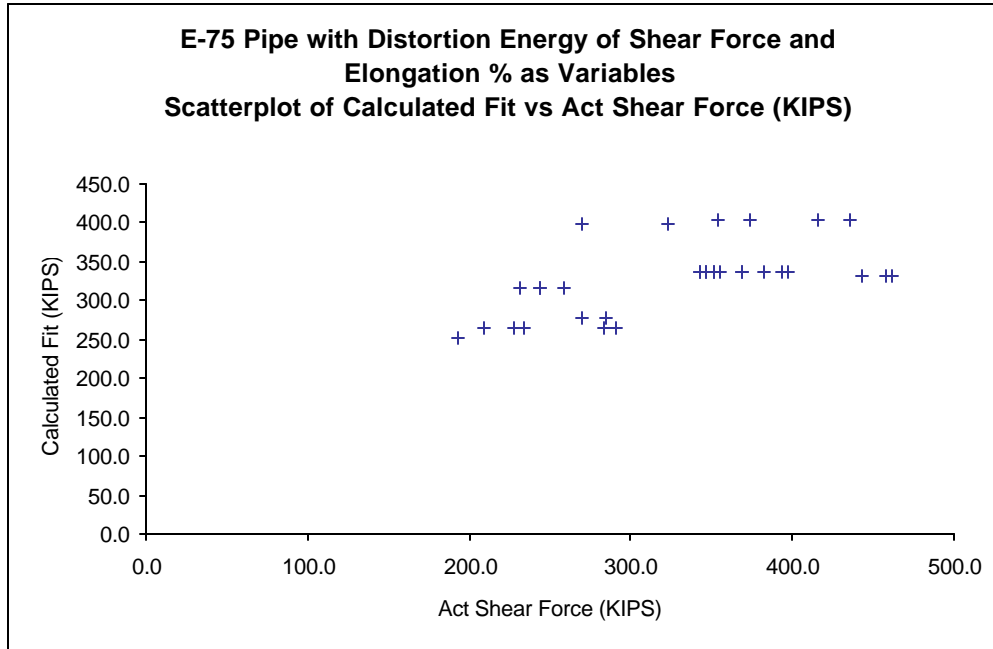

**Graph 5.16**

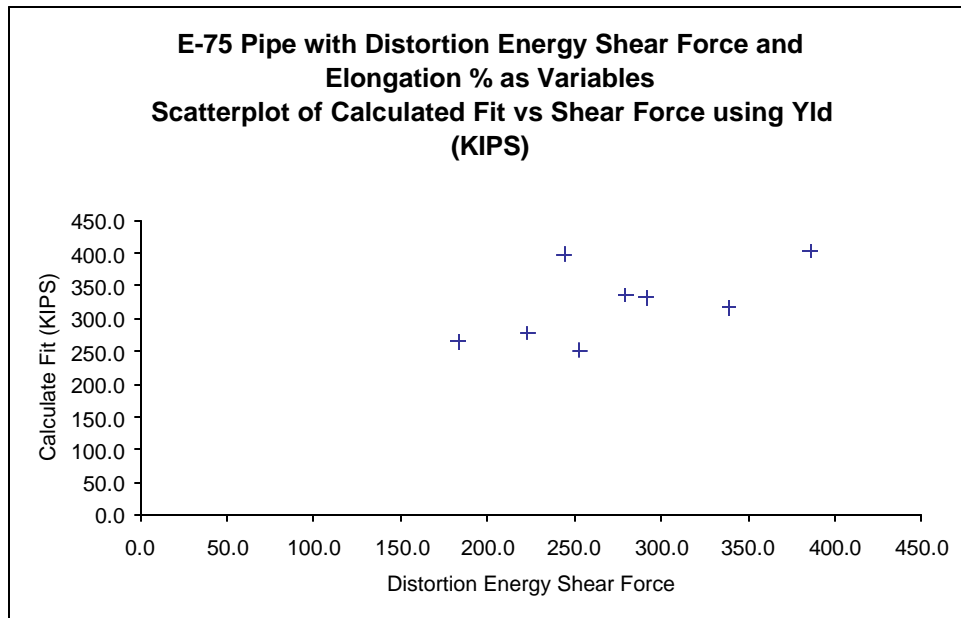

**Graph 5.17**

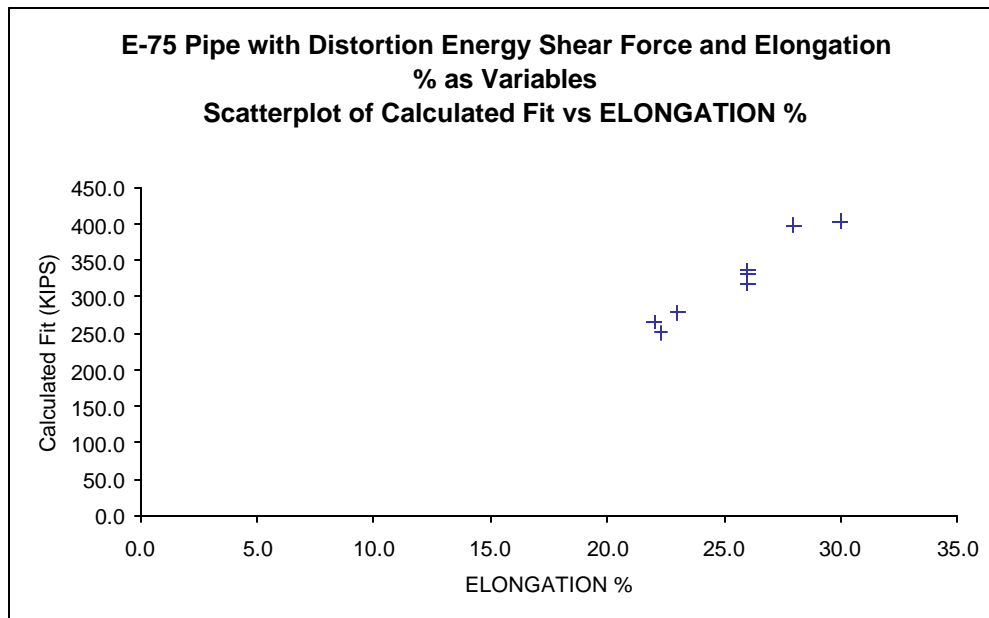

Elongation % is the dominant determinant of the data. From Table 5-3, note the 25.357 multiplier to Elongation %, coupled with a  $-0.318$  multiplier to Distortion Energy Theory Shear.

For harder pipe (S-135) Calculated Fit as a function of Distortion Energy Shear Force was basically a straight line with Elongation % having minimal effect on the line. For E-75 the Elongation % is the much more dominant factor. For E-75 pipe, the  $r^2$  using Elongation % as the only independent variable is 0.342, which is quite high. E-75 pipe with only Distortion Energy Shear Force as an independent variable resulted in an  $r^2$  of only 0.015. Thus the anomaly of E-75 pipe not fitting the Distortion Energy Shear Force equation can be better understood.

Finally S-135 pipe was examined. The regression analysis yielded the following equation:

$$\text{Calculated Fit (Shear Force)} = -35.11 + 0.630 \times (\text{Distortion Energy Shear Calc.}) + 4.489 \times (\text{Elongation \%})$$

Since this pipe is the most common in use today, additional information is included here. For this data the  $r^2$  using the two independent variables was 0.300. When using S-135 pipe and having the tensile strength and Elongation %, this equation coupled with the addition of two StErr of Estimate errors (153.38 plus 76.69 times 2) should offer a worst case shear force for planning purposes (97.725% chance of success). Of course, should a higher or lower chance of success be desired, the StErr of Estimate error multiplier would be changed accordingly.

The results were consistent with all the pipe results. Graphs 5.18 to 5.19 depicting S-135 pipe are shown below. See Attachment 5-1, which is a graph of the shear forces showing the actual, the calculated fit from the equation above and the calculated fit plus one and two StErr of Estimate errors. This shows that the equation for S-135 drill pipe developed using the statistical methods discussed above is acceptable for use. The equation plus two StErr of Estimate errors predicted 95.6% of the data used.

**Graph 5.18**

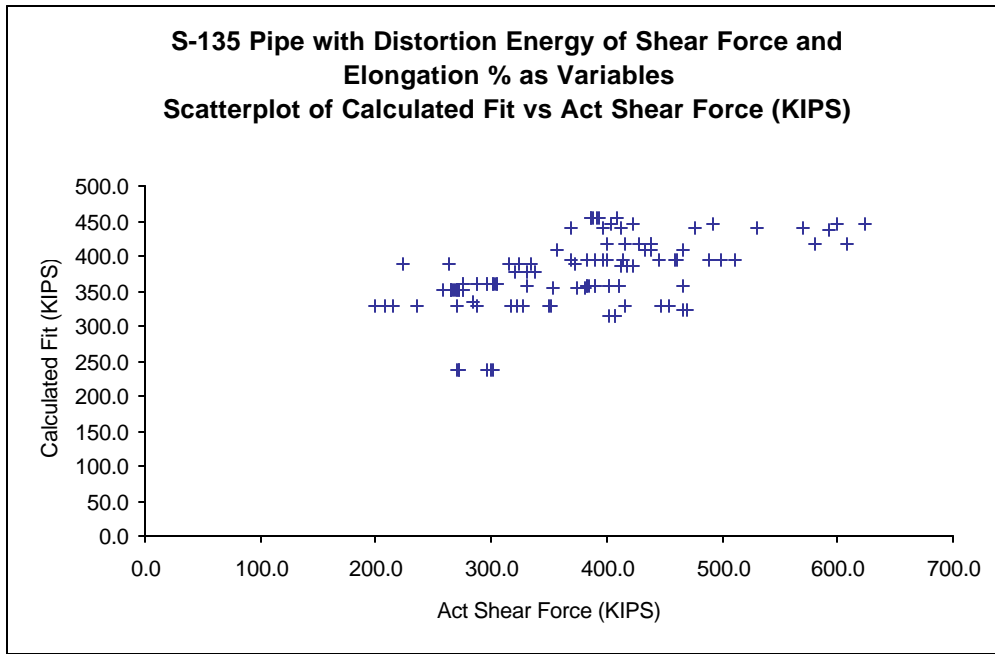

**Graph 5.19**

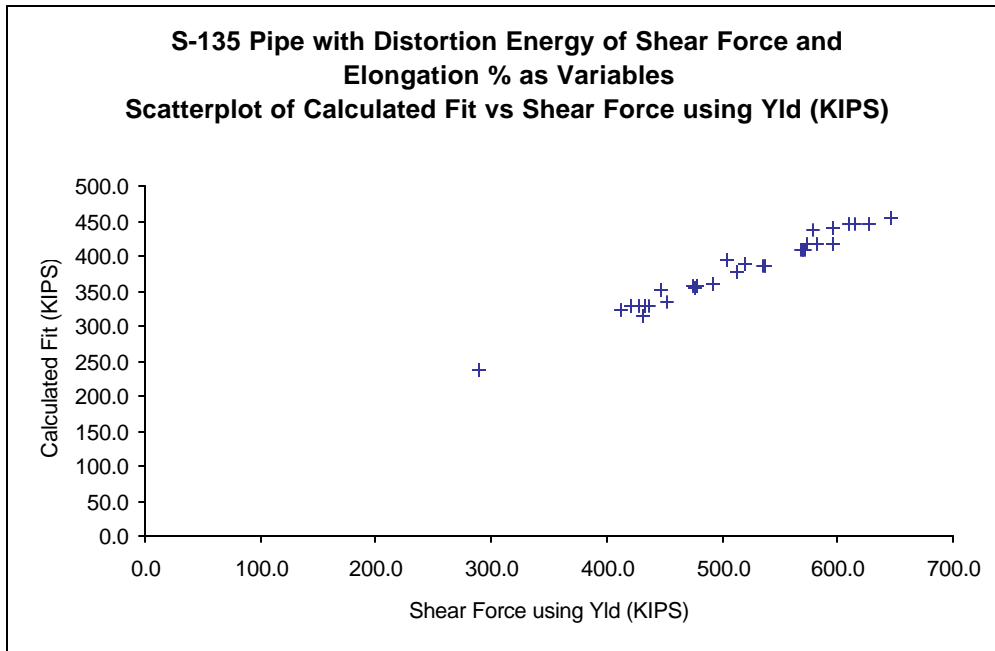

The above statistical review should have helped the reader to better understand the data and a means of predicting a successful shear. As can be seen, the data represents a pattern of shearing that does not fit a normal distribution but is similar to that of a normal distribution. The multiple regression analysis establishes the best fit to the data, which is useful in predicting future shearing. To that a safety factor (StErr) must be added to protect against those shears that are extreme. Should the regression analysis results be used in industry? First we believe that the results would be improved with more data; but with that said, the data assembled here certainly represents a reasonable approach to understanding a given situation. Confirmation of the data in cases where shearing is questionable is warranted.

Understanding that complete drill pipe material data will not always be available in the field, a different approach was checked. By trial and error, it was determined that using a multiplication factor of 1.045 with the shear force obtained using the Distortion Energy Theory shear equation (using material yield), provides an acceptable fit to the actual shear forces. See Attachment 5.2. Therefore, when Elongation % is not available, the Distortion Energy Theory shear equation with the 1.045 multiplication factor provides a good empirical fit for the data. However, when complete material information is available, the full calculation including Elongation, the Calculated Fit shear force should be used.

## 6 Additional Shearing Pressure Required

Additional pressures must be considered when shearing pipe, but are sometimes ignored. These include two major categories: net hydrostatic pressure at water depth and closing the rams against a wellbore kick. Hydrostatic pressure includes the net effect of the BOP hydraulic fluid, seawater, and mud weight.

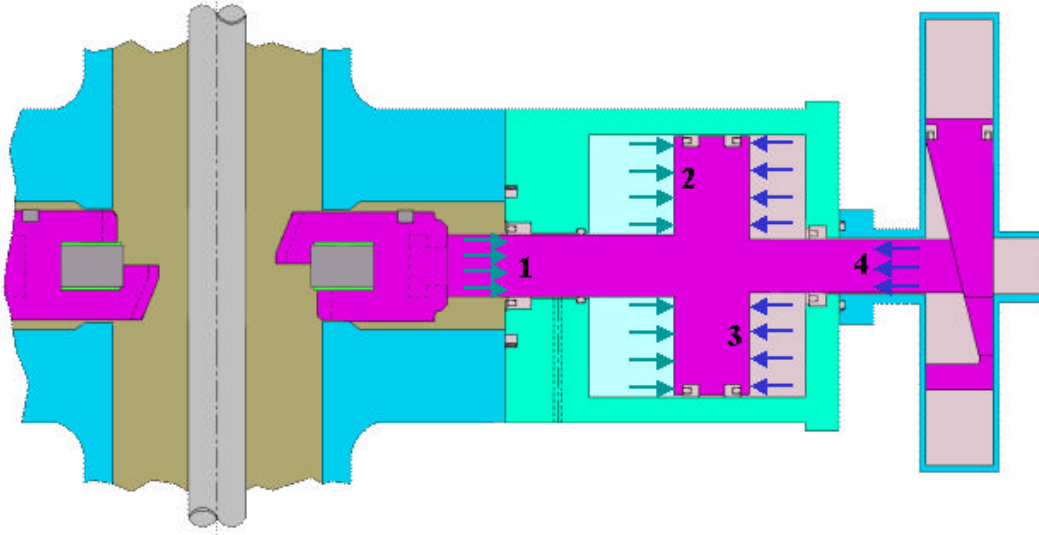

Areas where mud, seawater, and BOP fluid pressures act on a BOP with a wedge type lock:

- 1 – Mud Pressure
- 2 – Seawater Pressure
- 3 – BOP Fluid Pressure plus hydrostatic head
- 4 – Seawater Pressure.

Note: Area 4 and its pressure effects do not exist on BOPs without tailrods.

Closing against pressure in the wellbore increases the pressure required to close the rams by an amount equal to the pressure divided by the closing ratio of the ram BOP. This variable must be included since closing of the shear rams should be prepared for the worst case when there is wellbore pressure under the annular equal to its maximum working pressure. One BOP manufacturer stated that the working pressure of the ram BOP should be used, but it is difficult to determine a scenario where pressure could be contained under a shear ram while shearing is still needed. Another manufacturer lists wellbore pressures of 5,000 psi and 10,000 psi on some of their shear tables, which are presumably the working pressures of the annular BOPs in use.

Hydrostatic pressure includes those effects caused by BOP hydraulic fluid, seawater, and mud weight. The BOP hydraulic fluid pressure acts to close the ram while the mud acts to open the ram. The net effect is an increase in the pressure required to close the shear rams in order to overcome the opening forces of the mud. However, when the shear rams are closed and sealed and the pressure trapped between the shear ram and the annular vented, this wellbore pressure assists in maintaining the seal.



The total effect of these additive pressures can result in considerable increases in the shearing pressure established at the surface. These issues are not always considered when reviewing the capability of the control system to operate the shear rams and to shear the drill pipe.

The following tables and graphs can be used to determine the added closing pressure for selected BOPs for 12 ppg mud and kick pressures from 400 to 2500 psi. This is provided to allow an idea of the magnitude of the pressure.

To assist understanding, here is one possible scenario and the additional pressure determined:

Given: 18-3/4" 15K Hydril BOP with MPL and 19" operating pistons, 12 ppg mud, 6,000 ft water depth, 2000 psi kick pressure under the annular.

From the tables and graphs:

Closing ratio = 10.49:1

Additional pressure for the mud effects = 105 psi

Additional pressure for the kick pressure = 190 psi

Total additional closing pressure required = 295 psi

**SHAFFER®**

**Selected Closing Ratios**

<b>Model</b>	SLX & SL	SL	SL	SL	SL	SL	SL	SL
<b>Working Pressure (psi)</b>	15,000	15,000	15,000	10,000	10,000	10,000	5,000	5,000
<b>Bore (in)</b>	18-3/4	13-5/8	11	21-1/4	18-3/4	16-3/4	16-3/4	16-3/4
<b>Piston Size (in)</b>	14	14	14	14	14	14	10	14
<b>Closing Ratio</b>	10.85	7.11	7.11	7.11	7.11	7.11	5.54	10.85

## HYDRIL

### Selected Closing Ratios for Ram BOPs w/MPL

<b>Bore (in)</b>	16-3/4	18-3/4	18-3/4	18-3/4	18-3/4	20-3/4	21-1/4	21-1/4
<b>Working Pressure (psi)</b>	10,000	10,000	15,000	15,000	15,000	3,000	2,000	5,000
<b>Piston Size (in)</b>	14-1/4	14-1/4	15-1/2	19	22	14-1/4	14-1/4	14-1/4
<b>Closing Ratio</b>	10.6	10.6	7.27	10.49	14.64	10.6	10.6	10.6

## CAMERON

### Selected Closing Ratios

<b>Model</b>	U	U	U	UII	UII	T	T	TL W/ST Locks	TL W/ST Locks	TL W/ST Locks	TL W/Ram Locks	TL W/Ram Locks
<b>Working Pressure (psi)</b>	10K	5K	10K	10K	15K	10K	15K	5K	10K	15K	10K	15K
<b>Bore</b>	18-3/4	21-1/4	21-1/4	18-3/4	18-3/4	13-5/8	18-3/4	18-3/4	18-3/4	18-3/4	18-3/4	18-3/4
<b>Piston Size (in)</b>				18.00	19.02							
<b>Closing Ratio</b>	7.4:1	7.2:1	7.2:1	6.7:1	7.6:1	8.6:1	6.7:1	10.3:1	10.3:1	6.7:1	10.89:1	7.14:1

## Kick Pressure, psi

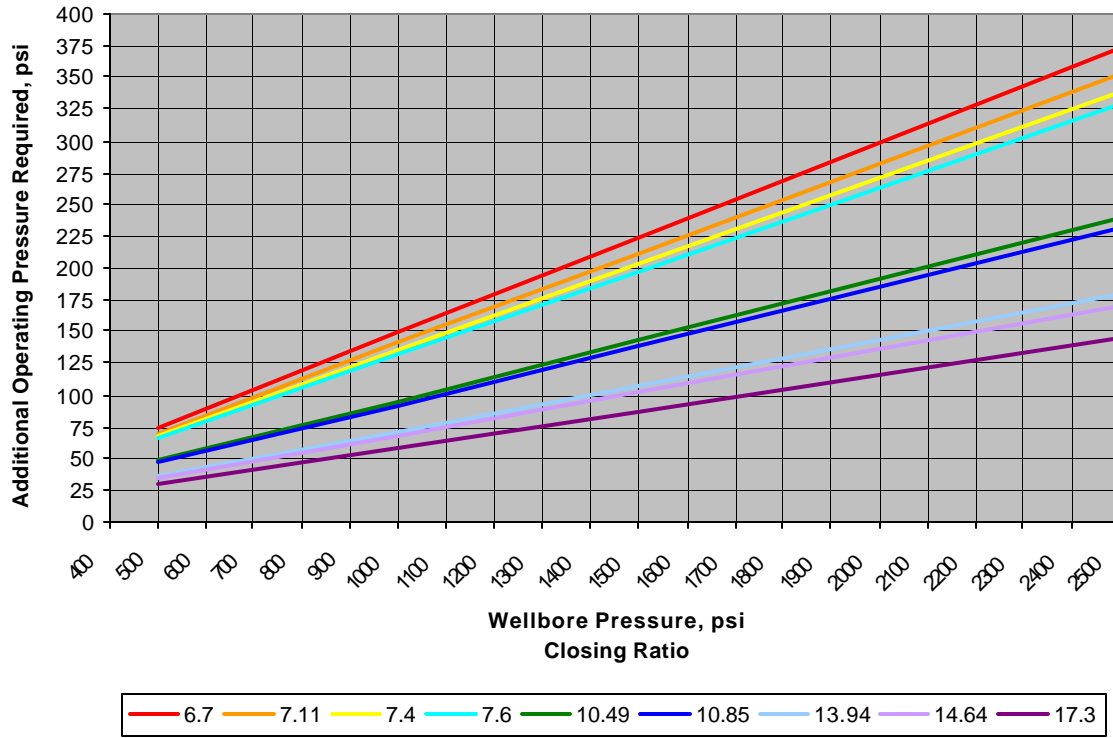

## 12 ppg Mud Weight

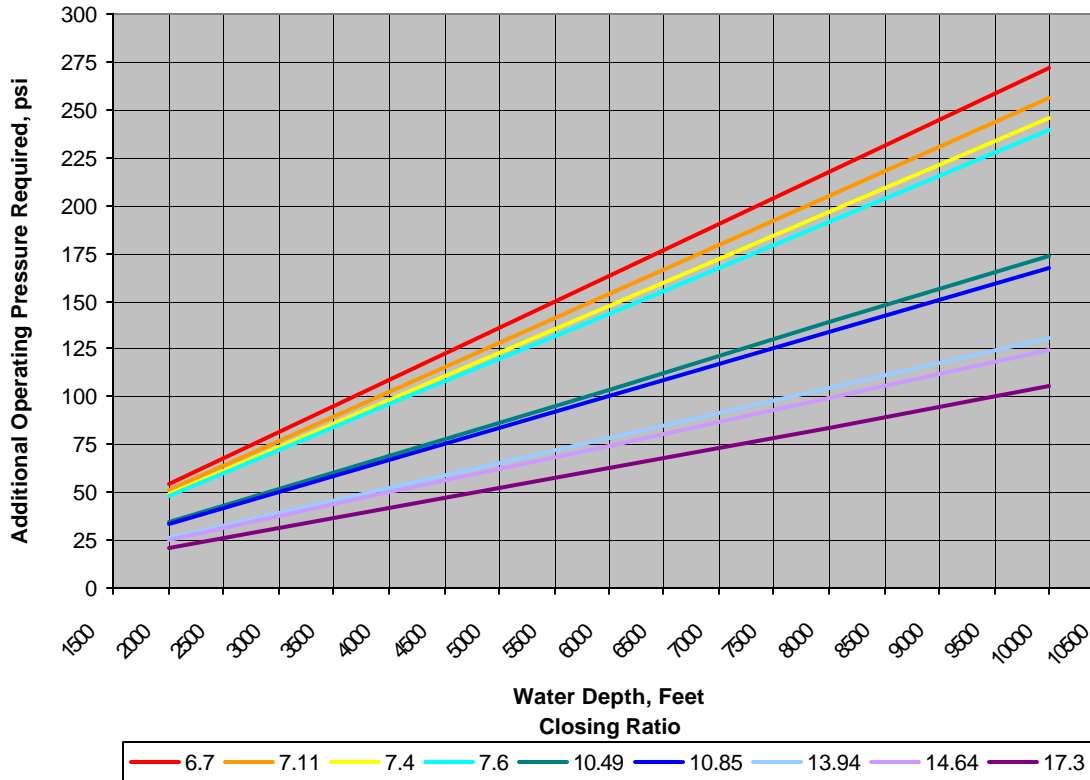

## 7 Test Procedures Used

The shear results and test information included in this study were for ram BOPs manufactured by three major manufacturers. The test procedures used complied with the requirements of API Specification 16A. Detailed below is a procedure from a manufacturer and from a drilling rig.

*Correlations among the test procedures.* The test procedures specify the basic equipment involved in the test and have the same acceptance criteria. Both tested with 5 ½-inch, 24.7 lb/ft, .415 inch wall, S-135 drill pipe.

*Differences among test procedures.* The primary difference between the procedures is the detail. The procedures developed by the manufacturer contained more definition than those developed by the operator for the drilling rig. The manufacturer's procedure included inspection of the shear ram assemblies and body cavity for damage between each test while those for the rig included only pressure tests following the shears.

### 7.1 Shear Ram Test

(from a major manufacturer of ram BOPs)

#### 1.0 Pressure Test Records

1.0.1 Strip Chart Recorders (with pens set at 0 – 1,000 psi, 0 – 5,000 psi, and 0 – 20,000 psi) shall be used to record low pressure, closing/shearing pressure, and high pressure tests respectively. The records shall identify the recording device and shall be dated and signed.

1.1 Shear rams shall be subjected to a minimum of nine shearing tests. The shear ram shall shear and seal in a single operation.

1.2 Pipe configuration to be sheared shall be 5 ½" S-135 24.7 lb/ft pipe.

#### 2.0 Shear Ram Test Procedure

2.0.1 Hook up BOP as per Figure 1.

2.0.2 Fill BOP cavity with water.

2.0.3 Close and open rams two times with 1500 psi hydraulic pressure to expel trapped air.

2.0.4 Suspend test sample in BOP wellbore on safety chain from bridge crane. Sample should extend approximately 18" - 25" below shear blade. Position the stabilization collar as close to the bottom of the bore as possible.

2.0.5 Set regulator to maintain 500 psi. Close the rams until the blades just contact the OD of the shear sample.

2.0.6 Place the operators in block mode and bleed hydraulic pressure to zero psi. With data acquisition and chart recorders running, place the shear rams in close position and slowly increase the operator pressure until pipe is sheared. DO NOT EXCEED 4500 psi. Bleed hydraulic pressure to zero psi.

2.0.7 Apply 300 ± 50 psi wellbore pressure under rams. Hold for a minimum of five minutes and check for leaks.

## ACCEPTANCE CRITERIA

The low-pressure test will be considered satisfactory if there is less than 10 psi pressure drop in five minutes after an initial stabilization period and no visible leakage.

- 2.0.8 Apply 15,000 +100/-0 psi wellbore pressure under rams and hold for a minimum of ten minutes and check for leaks. Bleed to zero psi (0 bar).

The high pressure test (15,000 psi) will be considered satisfactory if there is less than 100 psi pressure drop in ten minutes after an initial stabilization period and no visible leakage.

- 2.0.9 Open shear rams.
- 2.0.10 Open BOP and inspect shear ram assemblies and body cavity for any damage from shear test. Dress shear blades and replace damaged seals if necessary. Take digital photos of rams and sheared sample.
- 2.0.11 Repeat steps 2.0.2 through 2.0.10 for a minimum of nine shear and seal tests on three separate test samples.

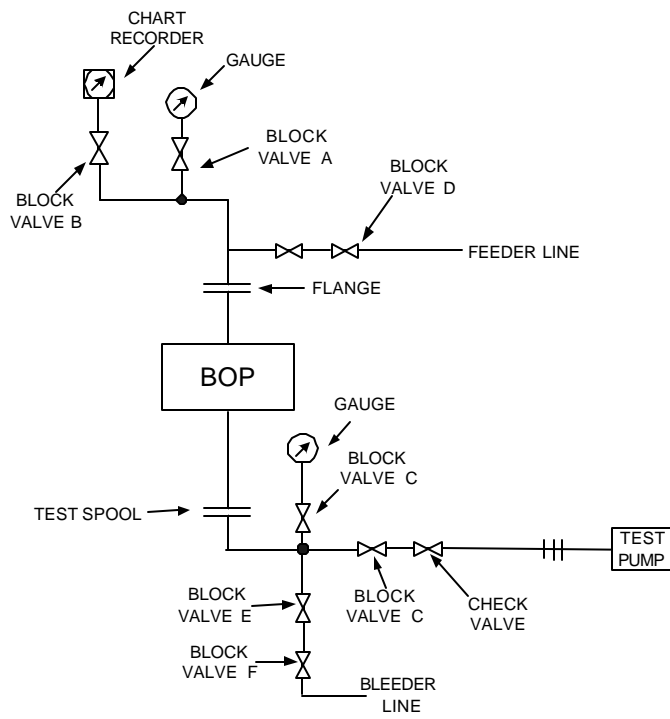

Figure 1 – Test Apparatus

## 7.2 Drilling Rig

This shear test procedure was developed by the operator during the rig acceptance phase. This procedure is not as specific as the previous one. There are no parameters for acceptable leakage rate during pressure testing.

1. The test setup is to include monitoring equipment capable of permanently recording operating pressure (e.g., chart recorder), time and volume required to shear pipe with the BOP stack shear blind rams. Accurate data must be collected during testing.
2. Connect a test hose to the BOP stack to be able to pressure test under the blind shear rams.

Note: Precautions should be made to prevent damage to the test stump by the bottom-sheared section of the drill pipe.

3. Fill the BOP stack with water to above the blind shear rams.
4. Assign yellow pod and use high-pressure shear circuit (3,000 psi operating pressure).
5. Suspend a section of 5 1/2" - 24.70 lb/ft - S135 drill pipe in the bore of the BOP and close the shear rams on the pipe. The pressure to shear should be evident on the chart recorder. **Record pressure, time, and volume.**
6. Pressure test the blind shear rams: 200 psi/10 minutes - 15,000 psi/15 minutes.
7. Open the shear rams and remove the sheared off section of drill pipe.
8. Fill the BOP stack with water to above the blind shear rams.
9. Assign blue pod and adjust the manifold regulator to 3,000 psi operating pressure.
10. Suspend a section of 5 1/2" - 24.70 lb/ft - S135 drill pipe in the bore of the BOP and close the shear rams on the pipe. The pressure to shear should be evident on the chart recorder. **Record pressure, time, and volume.**
11. Pressure test the blind shear rams: 200 psi/10 minutes - 15,000 psi/15 minutes.
12. Open the shear rams and remove the sheared off section of drill pipe.
13. Fill the BOP stack with water to above the blind shear rams.

Suspend a section of 5 1/2" - 24.70 lb/ft - S135 drill pipe in the bore of the BOP and close the shear rams on the pipe. The pressure to shear should be evident on the chart recorder. **Record pressure, time, and volume.**

## 8 Summary of Recommendations

The following recommendations are made in an effort to reduce the risk of an environmental event:

- The most conservative approach for new stacks would be to design them using the worst case information – maximum anticipated drill pipe OD and wall thickness, material strength, ductility (Elongation), pressure in the wellbore, etc.
- Existing stacks should be analyzed per the same. Larger operators or boosters may be required. Some ram BOP operators can be approved for operation at a pressure higher than 3000 psi. Shear boost control circuits can be considered.
- The maximum strength limit on drill pipe materials (Yield and Elongation) should be determined. This would be most helpful when material certs are not available and the worst case situation still needs to be analyzed.
- The longer tool joints and upsets desired by the users require the issue to be taken into account when considering the hang off location, ram space out and resulting shear point of the drill pipe. Consideration should be given to establishing a maximum length for tool joints and upsets.
- Drill pipe weight per foot should not be utilized because of resulting confusion, and instead standardize on the actual pipe wall thickness.
- An industry wide data base of shear forces/pressures should be established. Shear data available is lacking in complete detail and more information is needed to increase the viability of the equation(s). This data should be gathered in a consistent manner from shear tests performed to a prescribed procedure. The data for the drill pipe should be, at a minimum: pipe OD, pipe wall thickness, material grade, material actual yield strength, material actual ultimate strength, Charpy impact at a standardized temperature and Elongation %.
- Given the difficulty WEST had in obtaining the data for this study, encouragement of the industry participants to share data is warranted. The MMS could provide this encouragement and at the same time suggest similar test methods and procedures, see previous recommendation.
- It is doubtful that sufficient information can be gathered on casing, tubing or tubular combinations with wireline and cable, so issues with these should still be handled through actual shear tests.
- Use the following equations for drill pipe (adding 2 times StErr of Estimate ensures 97.25% probability) when full data is available (Symbols same as those used in Table 5-3):

Generally:

- Calc Fit Shear Force (Kips) = C + A x Distortion Energy Shear Calc. (Kips) + B x Elongation % + 2 x StErr of Estimate  
Or = C + A x (0.577 x Material Yield x Cross sec. Area of drill pipe) + B x Elongation % + 2 x StErr of Estimate

For S-135 Pipe:

- Calc Fit Shear Force (Kips) = -35.11+ 0.630 x Distortion Energy Shear Calc. (Kips) + 4.489 x Elongation % + 2 x 76.69

For G-105 Pipe:

- Calc Fit Shear Force (Kips) = 181.33+ 0.396 x Distortion Energy Shear Calc. (Kips) + 2.035 x Elongation % + 2 x 62.89

For E-75 Pipe:

- Calc Fit Shear Force (Kips) = -234.03+-0.318 x Distortion Energy Shear Calc. (Kips) + 25.357 x Elongation % + 2 x 62.03

In general the formula used is as follows:

$$Y = C + A \times X1 + B \times X2 + 2 \times \text{StErr of Estimate}$$

Where critical variables are as follows:

Y = Calculated fit shear force in Kips

C = Constant

X1 = Predicted shear using Energy Distortion Theory shear equation in Kips

A = Multiplier on X1 developed from Regression Analysis

X2 = Elongation %

B = Multiplier on X2 developed from Regression Analysis

StErr of Estimate = Standard Error (See Glossary of Terms)

- When complete material data is not available for the drill pipe in use, a good empirical shear force formula is as follows:

$$\text{Calc Fit Shear Force (Kips)} = \text{Distortion Energy Shear Calc. (Kips)} \times 1.045$$

$$\text{Or} = (0.577 \times \text{Material Yield (Kips)} \times \text{Cross sec. Area of drill pipe}) \times 1.045$$

Note: This worked for the data in the study better than substitution of ultimate strength for yield strength in the Distortion Energy Shear Equation.

- Develop a simple Excel spreadsheet requiring minimal input by the user. Only simple, available data would be input with the output being a risk adjusted shear force prediction. The correct equation from those detailed above would be automatically utilized. Then, using the closing area of the BOP in question, see Table 3.3 for examples, the predicted closing pressure could be obtained. It should still be remembered that the force (pressure) obtained may still be very conservative in some cases. This is preferable to the opposite of planning for a lower requirement and being unable to shear in an emergency.



## 9 Industry References

### 9.1 API Specification 16A, 2<sup>nd</sup> Edition

API Specification 16A, Specification for Drill Through Equipment, 2nd Edition, December 1997 makes specific reference as to how to test blind shear rams. The references from the specification are listed below.

#### 7.5.8.7.4 Shear-Blind Ram Test Procedure

Each preventer equipped with shear-blind rams shall be subjected to a shearing test. As a minimum, this test requires shearing of drill pipe as follows: 3 1/2-inch 13.3 lb/ft Grade E for 7 1/16-inch BOPs, 5-inch 19.5 lb/ft Grade E for 11-inch BOPs and 5-inch 19.5 lb/ft Grade G for 13 5/8-inch and larger BOPs. These tests shall be performed without tension in the pipe and with zero wellbore pressure. Shearing and sealing shall be achieved in a single operation. The piston closing pressure shall not exceed the manufacturer's rated working pressure for the operating system.

#### 4.7.2.4 Shear Ram Test

This test shall determine the shearing and sealing capabilities for selected drill pipe samples. As a minimum, the pipe used shall be: 3 1/2-inch 13.3 lb/ft Grade E for 7 1/16-inch BOPs, 5-inch 19.5 lb/ft Grade E for 11-inch BOPs and 5-inch 19.5 lb/ft Grade G for 13 5/8-inch and larger BOPs. These tests shall be performed without tension in the pipe and with zero well-bore pressure. Documentation shall include the manufacturer's shear ram and BOP configuration, the actual pressure and force to shear, and actual yield strength, elongation, and weight per foot of the drill pipe samples, as specified in API Specification 5D.

#### Appendix B.4.3 SHEAR RAM TEST (Non mandatory)

The following procedure is used for conducting a shear ram test on ram BOPs:

- a. Install the preventer on test stump. Connect opening and closing lines to BOP. Connect line from the high-pressure test pump to the stump or BOP side outlet.
- b. The opening, closing, and wellbore pressure line each shall be equipped with, as a minimum, a pressure transducer. All transducers shall be connected to a data acquisition system to provide a permanent record.
- c. Install a new set of ram packers onto the blocks. Durometer measurements on the ram rubber seal shall have been made and recorded.
- d. Suspend a section (approximately four feet in length) of drill pipe as specified in 4.7.2.4 for the preventer size vertically above the preventer and lower it into the wellbore. It is permitted to loosely guide the portion of the pipe below the ram to prevent excessive bending of the pipe section during shearing.
- e. Set closing unit manifold pressure to manufacturer's recommended pressure for shearing. Close the rams and shear the pipe in a single operation. The pressure at which the pipe is sheared will be obvious from the rapid pressure change at the instant of shearing.
- f. Raise the wellbore pressure to 200 to 300 psi and hold for three minutes examining for leaks.
- g. Raise wellbore pressure to maximum rated working pressure of preventer and again examine for leaks for three minutes.

- h. Reduce wellbore pressure to zero, open rams, inspect, and document any wear on the preventer.
- i. Repeat Items d through h for two additional samples of drill pipe. Ram packers may be replaced as necessary.

Critical items from the above API references are as follows:

- 7.5.8.7.4 – The spec requires that the specified pipe can be sheared and the wellbore sealed in one operation (within the BOP manufacturer’s recommended operating range) for pipe that was common at the time the spec was drafted. The drill pipe size and metallurgies have been enhanced since this time making this standard low and negating the intent. Prudent purchasers routinely require shearing of the drill pipe that will most likely be used on the rig.
- 4.7.2.4 – Once again the minimum specified pipe was for pipe in use when the spec was drafted; since that time, larger pipe with higher Charpy impact material has become common. The actual pressure and force to shear is recorded.
- B 4.3 – A procedure for performing a shear test is outlined. It includes a recommended method for examining for leaks and the recommendation that at least three shear tests be performed. It does not include use of the ram locking devices.

The pipe required in Section 4.7.2.4 is a low standard since many drilling programs use much heavier and stronger pipe. The 5-inch 19.5 lb/ft Grade G for 13 5/8-inch and larger BOPs is minimal and really does not address modern drill pipe. Drill pipe such as 6 5/8-inch .522” wall S-135 and heavier have been seen in deepwater drilling programs and require much greater shear forces than the lighter weight test drill pipe in API Specification 16A. The shearing/sealing of pipe more resembling that to be used in a program offers a much better assurance that shearing would occur when needed. Prudent purchasers require shearing of drill pipe that will be available on the rig.

Modifications to the procedure described in Section B.4.3 can further enhance the utility of shear info for other conditions. Specific guidelines ensure more uniform testing and results that are closer to actual shear values. For example, Section B.4.3 requires three shears for pipe. This does not establish enough data for statistical analysis of the shear rams’ capabilities, but instead establishes three points on a graph that includes the shear population for a given pipe. Not stated is which shear pressure should govern—WEST would recommend that it should be not be the average; but, rather, the largest measured result (worst case). As detailed above, the maximum drill pipe conditions should also be addressed so that greater assurance is achieved. In order to verify the ability to shear and seal in field situations, pressure testing should be performed with only the locking system holding the rams closed.

## **9.2 API RP 53 3<sup>rd</sup> Edition**

Section 13.3.2 “Note: The capability of the shear ram preventer and the operator should be verified with the equipment manufacturer for the planned drill string. The design of the shear BOP and or metallurgical differences among drill pipe manufacturers may necessitate high closing pressure for shear operations.”

## **9.3 MMS**

New MMS regulation 30 CFR Part 250.416(e) requires the lessee to provide information that shows that the blind-shear or shear rams installed in the BOP stack (both surface and subsea stacks) are capable of shearing the drill pipe in the hole under maximum anticipated surface pressures.

## 9.4 NPD

### Regulation: Section 26 paragraph 1

#### ***Design assumptions for drilling and well control equipment***

*“A barrier philosophy for each individual operation planned to be carried out from a facility shall be established at an early stage of the design phase. Functional requirements shall be defined with regard to the drilling and well control equipment’s suitability, operative capability and ability for mobilization for compliance with the barrier philosophy. All systems and components shall meet these requirements.”*

### Regulation: Section 26 paragraph 2

#### ***Design assumptions for drilling and well control equipment***

*“Pursuant to section 26, 6th paragraph of the regulations, it will not be possible to comply with all of these requirements for all types of equipment, for example, certain parts of the bottom hole assembly (BHA) will be unable to be cut by the BOP shear ram.”*

### Regulation: Guidelines, section, 31 Paragraph j

*“The acoustic accumulator unit shall have sufficient pressure for cutting the drillstring, after having closed a pipe ram preventer. In addition, the pressure shall be sufficient to carry out disconnection of the riser package (LMRP) after cutting of the drillstring has been completed.”*

## 9.5 UK

UK regulations are not specific in most cases, and rely on prudent and safe equipment maintenance by the contractor and safe operation by the operator. Due to this lack of specific regulations WEST conducts surveys in UK waters using API Specifications and Recommended Practices as guidelines for prudent operations and good oilfield practice.

The well operator is generally the petroleum company that operates the lease, and must ensure the following regulation is complied with.

### **Regulation 13: “General Duty”**

- (1) *“The well-operator shall ensure that a well is so designed, modified, commissioned, constructed, equipped, operated, maintained, suspended and abandoned that - ”*
- (a) *“so far as is reasonably practicable, there can be no unplanned escape of fluids from the well; and”*
- (b) *“risks to the health and safety of persons from it or anything in it, or in strata to which it is connected, are as low as is reasonably practicable.”*

## 9.6 NORSOK

### D-001 Standard: Section 5.10.3.1

Blow Out Preventer (BOP). The shear ram shall be capable of shearing the pipe *“body of the highest grade drill pipe in use, as well as closing off the wellbore.”*

### 9.7 Interpretation, all referenced regulatory requirements and standards:

The shear rams shall be qualified to shear all items passing through the BOP stack, except the bottom hole assembly. Shearing capability is related to the hydraulic pressure available to the rams. The shearing capability of the shear rams must be documented to assure that it is appropriate for the grades and weights of pipe(s) in use. (Note that drill collars, heavy weight drill pipe and large diameter casing cannot be sheared by standard, sealing blind shear rams.)

### 9.8 Discussion:

The operating system force required to shear the drill pipe at maximum conditions, at depth and with maximum pressure in the hole should be determined.

### 9.9 Internal WEST References

WEST ITP # 68, Effects of Wellbore Pressure on Closing Rams

#### **Paragraph 1**

The effects of the pressure in the wellbore are not always considered or understood *“when determining the pressures required to shear pipe or just to close a set of pipe rams. The effects can be bad enough to cause the inability to shear pipe in a well control situation. The same applies, to a lesser extent, to closing pipe rams.”*

## 10 Glossary of Terms

Bin Size	For the histograms plotted, the bin size affects the size and shape of the bars. Our choice herein was to allow the StatTool program to select the bin size. The default number of bins is based on the number of observations and the range of the data.
Charpy Impact Value	A measure of the ability of the material to withstand high-velocity loading, as measured by the energy, in ft-lb, which a notched-bar test specimen absorbs upon fracturing.
Chi-Square Test	A chi-square goodness of fit test checks whether the observed counts in various categories match the expected counts based on some null hypothesis. In our case we compared experienced counts to those that would be expected of a normal distribution.
Closing Ratio	For a ram BOP, this is the ratio of the operating system closing area to the area of the operating rod exposed to wellbore pressure. In other words, closing area divided by the wellbore pressure opening area.
Dependent variable	This variable is the one being predicted – in our case this is “Shear Force”.
Distortion Energy Theory	This theory says that failure occurs due to distortion of a part, not due to volumetric changes in the part. In pure shear stress, material failure occurs when the shear stress reaches .577 of the material tensile yield. The equation for shear force is then: Force, F, equals .577 times Tensile Yield Strength, $S_Y$ , times Cross sectional area of the material, $A_{CS}$ ( $F = .577 \times S_Y \times A_{CS}$ ).
Distortion Energy Shear Force	This is an abbreviation used herein for calculated Shear Force using the Distortion Energy Theory shear stress equation.
Ductility	The ability of a material to deform plastically without fracturing, usually measured by elongation or reduction of area in a tension test. The opposite of ductile is brittle.
Elongation %	A measure of ductility, expressed as a percentage of increase in length of a test specimen stretched to the point of fracture. It is of that specimen’s original gage length, such as 25% in 2 in.
Histogram	A histogram is a bar chart that shows how the data for a single variable is distributed.
Independent variable	The variable that the Regression Analysis uses to predict the value of a Dependent Variable. Herein we use “Predicted shear using distortion energy theory shear equation” as one variable and “% Elongation” as the second independent variable.

Least Squares Line	Also denoted as linear regression, the least squares method is applied to the following formula: $y = a + bx$ Then the differences between (y actual and y predicted) <sup>2</sup> are minimized.
Multiple Regression –	Multiple Regression applies the above technique to multiple variables using the following formula: $z = a + bx + cy$ It would be called a regression equation of z on x and y with z being the dependent variable.
Least Squares Method	Least squares is a method of fitting a curve to a set of points by minimizing the sum of the differences between the actual y's and the predicted y's. A measure of the goodness of fit of the curve to the data set is the sum of the squared differences.
Linear Correlation Coefficient	Also known as R Squared ( $r^2$ ) is defined by the following equation:  “ $r^2$ represents the fraction of the total variation that is explained by the least-squares regression line. In other words, r measures how well the least-squares regression line fits the sample data. If the total variation is all explained by the regression line, i.e., if $r^2 = 1$ , we can say that there is perfect correlation. On the other hand, if the total variation is all unexplained, then the explained variation is zero.” <sup>2</sup>
Mean	Average of a number of points is the mean.
Normal Distribution	The normal distribution is a most important example of a continuous probability distribution, also called the Gaussian distribution. Probability surrounds a mean with one standard deviation from the mean on both sides containing 68.27% of the data, two standard deviations containing 95.45% and three containing 99.73%.
Regression	Regression uses independent variable(s) to predict a dependent variable using a curve fitting technique. Should y be predicted using x by an equation, the equation is a regression equation of y on x.
Regression fit	The regression fit is the curve that predicts the Dependent variable(s) from independent variables.
Shear Force	The force in pounds required to shear the drill pipe. Here it is the pressure required to shear times the closing area of the BOP.
Standard Deviation	Standard deviation is a measurement of unpredictability of a variable. Standard deviation is the square root of the sum of the differences between points and their mean.

$$\sigma_x = \sqrt{\text{Var}(X)} = \sqrt{E[(X - \mu)^2]}$$

Standard Error

See Standard Error of Estimate

Standard Error of Estimate

(StErr of Estimate): Using  $Y_{est}$  to denote the estimated value of  $y$  for a given  $x$ , obtained from the regression curve of  $y$  on  $x$ , then the StErr of Estimate (measuring the scatter about the regression curve) is calculated from the formula below.

$$s_{y,x}^2 = \frac{\sum y^2 - a \sum y - b \sum xy}{n}$$

“The standard error of estimate has properties analogous to those of standard deviation. For example, if we construct pairs of lines parallel to the regression line of  $y$  on  $x$  at respective vertical distances  $s_{y,x}$ ,  $2s_{y,x}$ , and  $3s_{y,x}$  from it, we should find if  $n$  is large enough that there would be included between these pairs of lines about 68%, 95% and 99.7% of the sample points, respectively.”<sup>1</sup> The same applies for linear and multiple regressions.

Statistical Analysis

Statistical analysis is the entire process of analyzing data—including but not limited to understanding the shape and relevant measurements of the variable of interest and understanding how to predict variables based on a data history.

Strength, Tensile Yield

Also known as Yield Strength. The stress at which the material plastically deforms and will not return to its original dimensions when the load is released. See graph below.

Strength, Ultimate Tensile

Also known as Tensile Strength. The maximum resistance to fracture. The tensile strength is calculated by dividing the maximum load at fracture by the original cross-sectional area of the test specimen. See graph below.

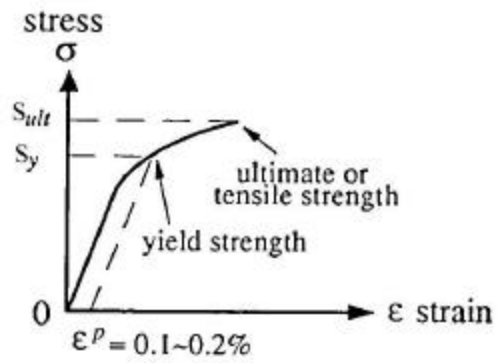

**Stress-Strain diagram of heat-treated steel.**

Greater distance between  $S_y$  and  $S_{ult}$  would indicate increased material ductility.

Stress Riser

A notch or defect that raises the stress locally and from which a fracture or crack could propagate.

<sup>1</sup>Spiegel, page 282.

<sup>2</sup>Spiegel, page 284.



## 11 Works Cited

Albright, Christian S. Learning Statistics with Stat Tools. New York: Palisade Corporation, 2003

American Petroleum Institute. Recommended Practices for Blowout Prevention Equipment Systems for Drilling Wells. 3<sup>rd</sup> ed. March 1997.

American Petroleum Institute, Specification for Drill Through Equipment 16A. 2<sup>nd</sup> ed. December 1997.

Baumeister, Theodore and Lionel S. Marks. Standard Handbook for Mechanical Engineers. 7<sup>th</sup> ed. New York: McGraw-Hill, 1967.

Bethlehem Steel Corporation. Modern Steels and Their Properties. 7<sup>th</sup> ed. Bethlehem, PA: 1972.

Code of Federal Regulations, Title 30 Mineral Resources, Part 250

Norwegian Petroleum Directorate. Volume 1 and 2. June 2000.

Norwegian Technology Standards Institution. Norsok Standards, Drilling Facilities D-001, Rev. 2, July 1998.

Spiegel, Murray R, John Schiller and R. Alu Srinivasan. Probability and Statistics. 2<sup>nd</sup> ed. New York: McGraw-Hill, 2000.

United Kingdom Health and Safety Executive (UK HSE) The Offshore Installations and Wells (Design and Construction, etc.) Regulations 1996 (SI 1996/913) (DCR)

## 12 Appendix

# A-1

## All Points Using Calculated Shear Force as Variable

Note: 18 shear data points did not have material yield data, therefore they are not in this table.

<i>Graph Data</i>	<i>Act Shear Force (KIPS)</i>	<i>Fit</i>	<i>Residual</i>	<i>Shear Force using Yld (KIPS)</i>
1	227.2660033	274.5012274	-47.2352241	183.2296984
2	208.9252381	274.5012274	-65.57598928	183.2296984
3	290.2625445	274.5012274	15.76131716	183.2296984
4	283.0857234	274.5012274	8.584496	183.2296984
5	234.4428244	274.5012274	-40.05840295	183.2296984
6	299.5126696	313.7149117	-14.20224215	289.573959
7	301.7454584	313.7149117	-11.96945335	289.573959
8	296.6419411	313.7149117	-17.07297062	289.573959
9	272.4002341	313.7149117	-41.31467763	289.573959
10	271.4433246	313.7149117	-42.27158712	289.573959
11	269.6889905	313.7149117	-44.02592118	289.573959
12	269.325	289.1637275	-19.83872749	222.993183
13	284.715	289.1637275	-4.448727494	222.993183
14	275.1114776	388.2562323	-113.1447547	491.7238399
15	287.0728462	388.2562323	-101.1833861	491.7238399
16	304.6161868	388.2562323	-83.64004551	491.7238399
17	301.4264885	388.2562323	-86.8297438	491.7238399
18	296.6419411	388.2562323	-91.61429124	491.7238399
19	275.1114776	388.2562323	-113.1447547	491.7238399
20	287.0728462	388.2562323	-101.1833861	491.7238399
21	304.6161868	388.2562323	-83.64004551	491.7238399
22	303.0213377	388.2562323	-85.23489465	491.7238399
23	301.4264885	388.2562323	-86.8297438	491.7238399
24	296.6419411	388.2562323	-91.61429124	491.7238399
25	193.2957165	300.1955625	-106.899846	252.9106047
26	382.4448252	309.9591373	72.4856878	279.3886103
27	397.1174373	309.9591373	87.15829995	279.3886103
28	393.4492843	309.9591373	83.49014691	279.3886103
29	351.3452668	309.9591373	41.38612946	279.3886103
30	342.2546267	309.9591373	32.29548933	279.3886103
31	346.5607194	309.9591373	36.60158203	279.3886103
32	351.3452668	309.9591373	41.38612946	279.3886103
33	342.2546267	309.9591373	32.29548933	279.3886103
34	346.5607194	309.9591373	36.60158203	279.3886103
35	369.2075772	309.9591373	59.24843989	279.3886103
36	368.5696376	309.9591373	58.61050024	279.3886103
37	355.4918746	309.9591373	45.53273724	279.3886103
38	443.5928827	314.3359123	129.2569704	291.2580611
39	461.4999609	314.3359123	147.1640486	291.2580611
40	458.3583682	314.3359123	144.0224559	291.2580611
41	269.325	296.9410375	-27.6160375	244.0846029
42	323.19	296.9410375	26.2489625	244.0846029
43	355.24	333.7508371	21.48916292	343.9097273
44	379.85	333.7508371	46.09916292	343.9097273

45	379.85	333.7508371	46.09916292	343.9097273
46	352.940116	334.5364121	18.40370389	346.0401415
47	372.7162454	345.085562	27.63068341	374.6485613
48	344.8063853	345.085562	-0.279176638	374.6485613
49	362.9876656	345.085562	17.90210362	374.6485613
50	308.6033097	345.085562	-36.48225225	374.6485613
51	310.6766136	345.085562	-34.40894836	374.6485613
52	307.3274304	345.085562	-37.75813156	374.6485613
53	308.6033097	345.085562	-36.48225225	374.6485613
54	310.6766136	345.085562	-34.40894836	374.6485613
55	307.3274304	345.085562	-37.75813156	374.6485613
56	311.4740382	345.085562	-33.61152378	374.6485613
57	389.6216463	345.085562	44.53608436	374.6485613
58	345.1253551	345.085562	0.039793191	374.6485613
59	455.5309348	352.1557369	103.375198	393.8222895
60	457.4158904	352.1557369	105.2601536	393.8222895
61	416.8893452	352.1557369	64.73360831	393.8222895
62	571.88001	351.4823869	220.3976231	391.9962201
63	406.6	366.0716367	40.52836329	431.561056
64	406.6	366.0716367	40.52836329	431.561056
65	401.25	366.0716367	35.17836329	431.561056
66	215.3046347	362.4804368	-147.1758021	421.8220195
67	207.3303889	362.4804368	-155.1500478	421.8220195
68	199.3561432	362.4804368	-163.1242935	421.8220195
69	354.0574921	382.3442615	-28.28676942	475.6910652
70	373.5353666	382.3442615	-8.808894969	475.6910652
71	380.7610297	382.3442615	-1.583231865	475.6910652
72	272.6598082	372.0195616	-99.35975346	447.6913352
73	268.88597	372.0195616	-103.1335916	447.6913352
74	270.5841972	372.0195616	-101.4353645	447.6913352
75	275.4901868	372.0195616	-96.52937483	447.6913352
76	271.7163486	372.0195616	-100.303213	447.6913352
77	275.3014949	372.0195616	-96.71806673	447.6913352
78	264.9234399	372.0195616	-107.0961217	447.6913352
79	266.0555914	372.0195616	-105.9639703	447.6913352
80	269.8294296	372.0195616	-102.1901321	447.6913352
81	265.3008237	372.0195616	-106.7187379	447.6913352
82	257.9418393	372.0195616	-114.0777223	447.6913352
83	264.5460561	372.0195616	-107.4735055	447.6913352
84	327.1035598	366.9694367	-39.86587691	433.9958151
85	317.0560102	366.9694367	-49.91342653	433.9958151
86	322.7974671	366.9694367	-44.1719696	433.9958151
87	287.2323312	366.9694367	-79.73710555	433.9958151
88	269.5295056	366.9694367	-97.43993107	433.9958151
89	236.1971585	366.9694367	-130.7722782	433.9958151
90	350.8668121	366.9694367	-16.10262464	433.9958151
91	350.0693875	366.9694367	-16.90004921	433.9958151
92	384.75	382.2320365	2.517963469	475.3867203
93	330.1155	382.2320365	-52.11653653	475.3867203
94	284.715	373.9273866	-89.21238662	452.8651984
95	469.395	359.1136868	110.2813132	412.6916727
96	465.5475	359.1136868	106.4338132	412.6916727
97	415.53	368.0916867	47.43831331	437.039264
98	446.31	364.8371617	81.47283827	428.2132622
99	454.005	364.8371617	89.16783827	428.2132622

100	232.0505507	331.914665	-99.86411429	338.9301808
101	244.0119193	331.914665	-87.90274569	338.9301808
102	258.3655616	331.914665	-73.54910338	338.9301808
103	244.0119193	331.914665	-87.90274569	338.9301808
104	354.0565104	349.2100667	4.846443684	385.8338761
105	373.1947001	349.2100667	23.98463343	385.8338761
106	416.255627	349.2100667	67.04556037	385.8338761
107	435.3938168	349.2100667	86.18375012	385.8338761
108	291.8573937	388.4631087	-96.60571507	492.2848715
109	304.6161868	388.4631087	-83.84692191	492.2848715
110	282.2882988	388.4631087	-106.1748099	492.2848715
111	309.4007343	388.4631087	-79.06237447	492.2848715
112	402.8572252	381.9961325	20.86109278	474.7469681
113	454.3701163	381.9961325	72.37398388	474.7469681
114	440.595607	381.9961325	58.59947454	474.7469681
115	445.6902885	381.9961325	63.69415607	474.7469681
116	444.3694452	381.9961325	62.37331271	474.7469681
117	436.8217688	381.9961325	54.82563636	474.7469681
118	441.3503746	381.9961325	59.35424217	474.7469681
119	438.7086879	378.2362625	60.47242538	464.5505126
120	455.3135759	378.2362625	77.07731335	464.5505126
121	446.82244	378.2362625	68.58617746	464.5505126
122	433.6140064	378.2362625	55.37774384	464.5505126
123	437.0104607	378.2362625	58.7741982	464.5505126
124	423.0472595	378.2362625	44.81099695	464.5505126
125	446.6337481	378.2362625	68.39748555	464.5505126
126	442.2938342	378.2362625	64.05757165	464.5505126
127	445.8789804	378.2362625	67.64271791	464.5505126
128	451.9171215	378.2362625	73.68085899	464.5505126
129	451.5397377	381.9961325	69.54360525	474.7469681
130	447.5772076	381.9961325	65.58107516	474.7469681
131	425.3115624	381.9961325	43.31542993	474.7469681
132	396.4417003	392.9427682	3.498932173	504.4333365
133	400.4042304	392.9427682	7.461462258	504.4333365
134	458.7100302	392.9427682	65.76726207	504.4333365
135	369.8361412	392.9427682	-23.10662696	504.4333365
136	460.0308736	392.9427682	67.08810543	504.4333365
137	511.7324566	392.9427682	118.7896884	504.4333365
138	499.4674825	392.9427682	106.5247144	504.4333365
139	390.2148674	392.9427682	-2.727900817	504.4333365
140	414.3674317	392.9427682	21.42466351	504.4333365
141	445.5015966	392.9427682	52.55882846	504.4333365
142	382.1011153	392.9427682	-10.84165289	504.4333365
143	488.145968	392.9427682	95.20319984	504.4333365
144	330.885	396.2908794	-65.40587941	513.5131365
145	338.58	396.2908794	-57.71087941	513.5131365
146	320.112	396.2908794	-76.17887941	513.5131365
147	592.5777	420.3532276	172.2244724	578.7682297
148	397.062	426.4186047	-29.35660467	595.2170294
149	569.43	426.4186047	143.0113953	595.2170294
150	477.09	426.4186047	50.67139533	595.2170294
151	411.6825	426.4186047	-14.73610467	595.2170294
152	369.36	426.4186047	-57.05860467	595.2170294
153	530.955	426.4186047	104.5363953	595.2170294
154	356.2785	417.532122	-61.25362201	571.1176252

155	607.905	421.6227251	186.2822749	582.2110017
156	580.9725	421.6227251	159.3497749	582.2110017
157	433.998	416.8268456	17.1711544	569.2049741
158	465.5475	416.8268456	48.7206544	569.2049741
159	600.21	432.0608159	168.1491841	610.5182384
160	492.48	432.0608159	60.41918412	610.5182384
161	417.3	404.6654009	12.63459907	536.2241445
162	411.95	404.8224532	7.127546793	536.6500573
163	422.65	404.8224532	17.82754679	536.6500573
164	401.7424998	383.5595165	18.18298335	478.9867358
165	402.2209546	383.5595165	18.6614381	478.9867358
166	466.0149204	383.5595165	82.45540393	478.9867358
167	389.7811312	383.5595165	6.221614762	478.9867358
168	409.8762305	383.5595165	26.316714	478.9867358
169	382.2853402	383.5595165	-1.274176224	478.9867358
170	389.7811312	383.5595165	6.221614762	478.9867358
171	409.8762305	383.5595165	26.316714	478.9867358
172	382.2853402	383.5595165	-1.274176224	478.9867358
173	323.2759218	398.5558028	-75.27988095	519.655421
174	314.5042515	398.5558028	-84.05155125	519.655421
175	334.120896	398.5558028	-64.43490676	519.655421
176	262.6716543	398.5558028	-135.8841485	519.655421
177	373.1947001	398.5558028	-25.36110269	519.655421
178	223.4383653	398.5558028	-175.1174375	519.655421
179	438.615	416.3291792	22.28582081	567.8553441
180	400.14	418.5508512	-18.41085124	573.8803345
181	415.53	418.5508512	-3.020851244	573.8803345
182	423.225	438.1293362	-14.90433618	626.9755623
183	403.9875	438.1293362	-34.14183618	626.9755623
184	469.9	411.6847363	58.21526371	555.26
185	533.4	411.6847363	121.7152637	555.26
186	558.8	411.6847363	147.1152637	555.26
187	438.7	426.8520959	11.84790406	596.3926218
188	428	426.8520959	1.147904056	596.3926218
189	438.7	426.8520959	11.84790406	596.3926218
190	390.8141262	445.0135996	-54.19947345	645.6451138
191	409.3495228	445.0135996	-35.66407679	645.6451138
192	385.7875779	445.0135996	-59.22602169	645.6451138
193	392.6990818	445.0135996	-52.31451785	645.6451138
194	388.9291706	445.0135996	-56.08442904	645.6451138
195	387.044215	445.0135996	-57.96938463	645.6451138
196	624.61659	433.67706	190.93953	614.9013583